

Induction Hob

User manual

NZ64K7757BK



SAMSUNG

Contents

Using this manual	3	Switching the appliance off	18
Safety instructions	3	Quick stop	18
Disposing of the packaging material	6	Using the child safety lock	19
Proper disposal of your old appliance	6	Timer (Count down)	19
Correct Disposal of This Product (Waste Electrical & Electronic Equipment)	7	Timer (Count up)	20
Installing the hob	7	Using keep warm	21
Safety instructions for the installer	7	Power boost control	21
Connecting to the mains power supply	8	Power management	22
Installing into the countertop	9	Pause	22
Parts and features	11	Flex control	22
Cooking zones	11	Sound on/off	23
Control panel	12	Suggested settings for cooking specific foods	23
Components	12	Cleaning and care	24
Induction heating	12	Hob	24
The key features of your appliance	13	Light soiling	24
Safety shutoff	14	Stubborn soiling	24
Flex zone Plus	14	Problem dirt	25
Residual heat indicator	15	Hob frame (option)	25
Temperature detection	15	To avoid damaging your appliance	25
Hob use	15	Warranty and service	26
Initial cleaning	15	FAQs and troubleshooting	26
Cookware for induction cooking zones	15	Service	27
Suitability test	16	Technical data	28
Size of pans	16	Technical data	28
Operating noises	16	Cooking zones	28
Using suitable cookware	17	Product information	28
Using the touch control sensors	17		
Switching the appliance on	17		
Select cooking zone and heat setting	18		

Using this manual

Please take the time to read this owner's manual, paying particular attention to the safety information contained in the following section, before using your appliance. Keep this manual for future reference.

If transferring ownership of the appliance, please remember to pass the manual on to the new owner.

The following symbols are used in this User Manual:

WARNING

Hazards or unsafe practices that may result in **severe personal injury or death**.

CAUTION

Hazards or unsafe practices that may result in **minor personal injury or property damage**.

CAUTION

To reduce the risk of fire, explosion, electric shock, or personal injury when using your hob, follow these basic safety precaution.

NOTE

Useful tips, recommendations, or information that helps users manipulate the product.

Safety instructions

The safety aspects of this appliance comply with all accepted technical and safety standards. However, as manufacturers we also believe it is our responsibility to familiarize you with the following safety instructions.

WARNING

This appliance is not intended for use by persons (including children) with reduced physical, sensory or mental capabilities, or lack of experience and knowledge, unless they have been given supervision or instruction concerning use of the appliance by a person responsible for their safety.

Children should be supervised to ensure that they do not play with the appliance.

If the supply cord is damaged, it must be replaced by the manufacturer, its service agent or similarly qualified persons in order to avoid a hazard.

Appliance should allow the disconnection of the appliance from the supply after installation. The disconnection may be achieved by having the plug accessible or by incorporating a switch in the fixed wiring in accordance with the wiring rules.

WARNING: If the surface is cracked, switch off the appliance to avoid the possibility of electric shock.

During use the appliance becomes hot. Care should be taken to avoid touching heating elements inside the hob.



Safety instructions

WARNING: Accessible parts may become hot during use. Young children should be kept away.

A steam cleaner is not to be used to clean the product.

Metallic objects such as knives, forks, spoons and lids should not be placed on the hob surface since they can get hot.

After use, switch off the hob element by its control and do not rely on the pan detector.

Do not use harsh abrasive cleaners or sharp metal scrapers to clean the hob glass since they can scratch the surface, which may result in shattering of the glass.

Appliance is not intended to be operated by means of an external timer or separate remote-control system.

WARNING: The appliance and its accessible parts become hot during use. Care should be taken to avoid touching heating elements inside the hob. Children less than 8 years of age shall be kept away unless continuously supervised.

This appliance can be used by children aged from 8 years and above and persons with reduced physical, sensory or mental capabilities or lack of experience and knowledge if they have been given supervision or instruction concerning use of the appliance in a safe way and understand the hazards involved. Children shall not play with the appliance. Cleaning and user maintenance shall not be made by children without supervision.

WARNING: Unattended cooking on a hob with fat or oil can be dangerous and may result in fire.

NEVER try to extinguish a fire with water, but switch off the appliance and then cover flame e.g. with a lid or a fire blanket.

WARNING: Danger of fire: do not store items on the cooking surfaces.

WARNING: Use only hob guards designed by the manufacturer of the cooking appliance. The use of inappropriate guards can cause accidents.

The temperature of accessible surfaces may be high when the appliance is operating.

Keep the appliance and its cord out of reach of children less than 8 years.



CAUTION

Be sure the appliance is properly installed and grounded by a qualified technician.

The appliance should be serviced only by qualified service personnel. Repairs carried out by unqualified individuals may cause injury or serious malfunction. If your appliance is in need of repair, contact your local service centre. Failure to follow these instructions may result in damage and void the warranty. Flush - mounted appliances may be operated only after they have been installed in cabinets and workplaces that conform to the relevant standards. This ensures sufficient protection against contact for electrical units as required by the essential safety standards.

If your appliance malfunctions or if fractures, cracks or splits appear:

- switch off all cooking zones;
- disconnect the hob from the mains supply; and
- contact your local service centre.

If the cooktop cracks, turn the appliance off to avoid the possibility of electric shock. Do not use your hob until the glass surface has been replaced.

Do not use the hob to heat aluminium foil, products wrapped in aluminium foil or frozen foods packaged in aluminium cookware.

Liquid between the bottom of the pan and the hob can produce steam pressure. Which may cause the pan to jump.

Always ensure that the hotplate and the base of the pan are kept dry.

The cooking zones will become hot when you cook.

Always keep small children away from the appliance.

Keep all packaging materials well out of the reach of children, as packaging materials can be dangerous to children.

This appliance is to be used only for normal cooking and frying in the home. It is not designed for commercial or industrial use.

Never use the hob for heating the room.

Take care when plugging electrical appliances into mains sockets near the hob. Mains leads must not come into contact with the cooktop.

Overheated fat and oil can catch fire quickly. Never leave surface units unattended when preparing foods in fat or oil, for example, when cooking chips.

Turn the cooking zones off after use.



Safety instructions

Always keep the control panels clean and dry.

Never place combustible items on the hob, it may cause fire.

There is the risk of burns from the appliance if used carelessly.

Cables from electrical appliances must not touch the hot surface of the hob or hot cookware.

Do not use the hob to dry clothes.

Users with Pacemakers and Active Heart Implants must keep their upper body at a minimum distance of 30 cm from induction cooking zones when turned on. If in doubt, you should consult the manufacturer of your device or your doctor. (Induction hob model only)

Do not attempt to repair, disassemble, or modify the appliance yourself.

Always turn the appliance off before cleaning.

Clean the hob in accordance with the cleaning and care instructions contained in this manual.

Disposing of the packaging material

WARNING

All materials used to package the appliance are fully recyclable. Sheet and hard foam parts are appropriately marked. Please dispose of packaging materials and old appliances with due regard to safety and the environment.

Proper disposal of your old appliance

WARNING

Before disposing of your old appliance, make it inoperable so that it cannot be a source of danger. To do this, have a qualified technician disconnect the appliance from the mains supply and remove the mains lead.

The appliance may not be disposed of in the household rubbish.

Information about collection dates and public refuse disposal sites is available from your local refuse department or council.



Correct Disposal of This Product (Waste Electrical & Electronic Equipment)



(Applicable in countries with separate collection systems)
This marking on the product, accessories or literature indicates that the product and its electronic accessories (e.g. charger, headset, USB cable) should not be disposed of with other household waste at the end of their working life. To prevent possible harm to the environment or human health from uncontrolled waste disposal, please separate these items from other types of waste and recycle them responsibly to promote the sustainable reuse of material resources.

Household users should contact either the retailer where they purchased this product, or their local government office, for details of where and how they can take these items for environmentally safe recycling.

Business users should contact their supplier and check the terms and conditions of the purchase contract. This product and its electronic accessories should not be mixed with other commercial wastes for disposal.

Installing the hob

⚠ WARNING

Be sure the new appliance is installed and grounded only by qualified personnel. Please observe this instruction. The warranty will not cover any damage that may occur as a result of improper installation.

Technical data is provided at the end of this manual.

Safety instructions for the installer

- A device must be provided in the electrical installation that allows the appliance to be disconnected from the mains at all poles with a contact opening width of at least 3 mm. Suitable isolation devices include line protecting cut - outs, fuses (screw type fuses are to be removed from the holder), earth leakage trips and contactors.
- With respect to fire protection, this appliance corresponds to EN 60335 - 2 - 6. This type of appliance may be installed with a high cupboard or wall on one side.
- The installation must guarantee shock protection.
- The kitchen unit in which the appliance is fitted must satisfy the stability requirements of DIN 68930.
- For protection against moisture, all cut surfaces are to be sealed with a suitable sealant.
- On tiled work surfaces, the joints in the area where the hob sits must be completely filled with grout.
- On natural, artificial stone, or ceramic tops, the snap action springs must be bonded in place with a suitable artificial resin or mixed adhesive.
- Ensure that the seal is correctly seated against the work surface without any gaps. Additional silicon sealant must not be applied; this would make removal more difficult when servicing.
- The hob must be pressed out from below when removed.
- A board can be installed underneath the hob.
- The ventilation gap between the worktop and front of the unit underneath it must not be covered.



Installing the hob

Connecting to the mains power supply

Before connecting, check that the nominal voltage of the appliance, that is, the voltage stated on the rating plate, corresponds to the available supply voltage. The rating plate is located on the lower casing of the hob.

⚠ WARNING

Shut off power to circuit before connecting wires to circuit.

The heating element voltage is AC 230 V~. The appliance also works perfectly on networks with AC 220 V~ or AC 240 V~. The hob is to be connected to the mains using a device that allows the appliance to be disconnected from the mains at all poles with a contact opening width of at least 3 mm, eg. automatic line protecting cut - out, earth leakage trips or fuse.

⚠ WARNING

The cable connections must be made in accordance with regulations and the terminal screws tightened securely.

⚠ WARNING

Once the hob is connected to the mains supply, check that all cooking zones are ready for use by briefly switching each on in turn at the maximum setting with suitable cookware.

⚠ WARNING

Pay attention (conformity) to phase and neutral allocation of house connection and appliance (connection schemes); otherwise, components can be damaged. Warranty does not cover damage resulting from improper installation.

⚠ WARNING

If the supply cord is damaged, it must be replaced by the manufacturer, its service agent or similarly qualified persons in order to avoid a hazard.

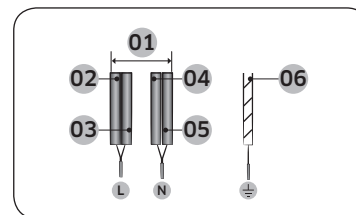

1N~ (32A)

01	220-240 V ~	04	Blue
02	Brown	05	Gray
03	Black	06	Green/Yellow

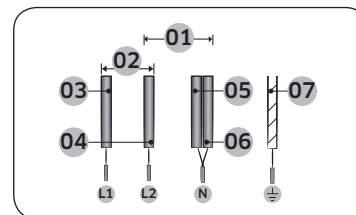

2N~ (16A): Separate the 2-phase wires (L1 and L2) before connection.

01	220-240 V ~	05	Blue
02	380-415 V ~	06	Gray
03	Brown	07	Green/Yellow
04	Black		

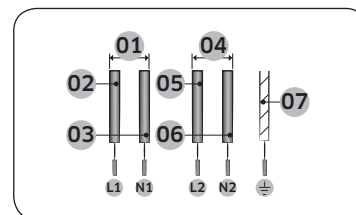

2 x 1N~ (16A): Separate the wires before connection.

01	220-240 V ~	05	Black
02	Brown	06	Gray
03	Blue	07	Green/Yellow
04	220-240 V ~		

⚠ WARNING

For correct supply connection, follow the wiring diagram attached near the terminals.



Installing into the countertop

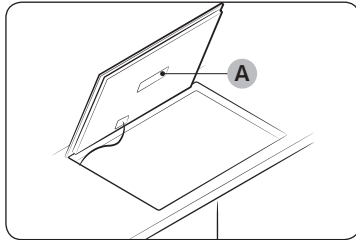

A. Serial number

NOTE

Make a note of the serial number on the appliance rating label prior to installation. This number will be required in the case of requests for service and is no longer accessible after installation, as it is on the original rating plate on the underside of the appliance.

NOTE

Pay special attention to the minimum space and clearance requirements.

NOTE

The bottom of the hob is equipped with a fan. If there is a drawer under the hob it should not be used to store small objects or paper, since they could damage the fan or interfere with the cooling if they are sucked into it.

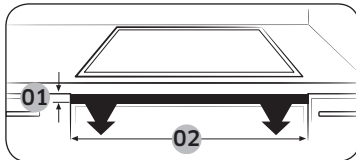

No.	Explanation	Size
01	Height of ventilation hole	Min 2 mm
02	Width of ventilation hole	560 mm

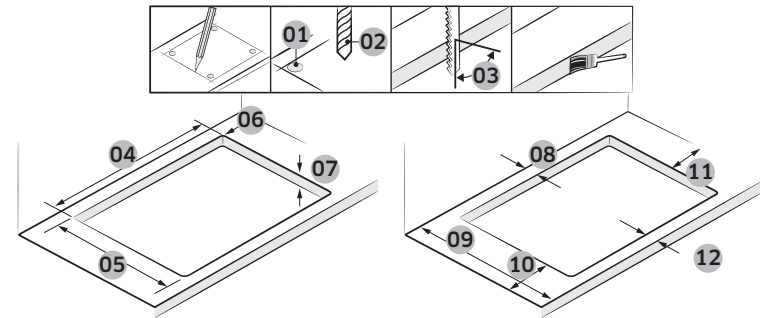

No.	Explanation	Size
01	Check 4 Point	
02	Drill diameter	Ø 6
03	Right angle of cutting point	90 °
04	Cutting Width Size	560±1 mm
05	Cutting Depth Size	490±1 mm
06	Curve Size	R3
07	Size of table thickness	Max 50 mm, Min 20 mm
08	Distance between end of table and cutting point (Rear-side)	Min 60 mm
09	Depth of table	Min 600 mm
10	Distance between end of table and cutting point (Left-side)	Min 60 mm
11	Distance between end of table and cutting point (Right-side)	Min 60 mm
12	Distance between end of table and cutting point (Front-side)	Min 50 mm

Installing the hob

Installing the hob

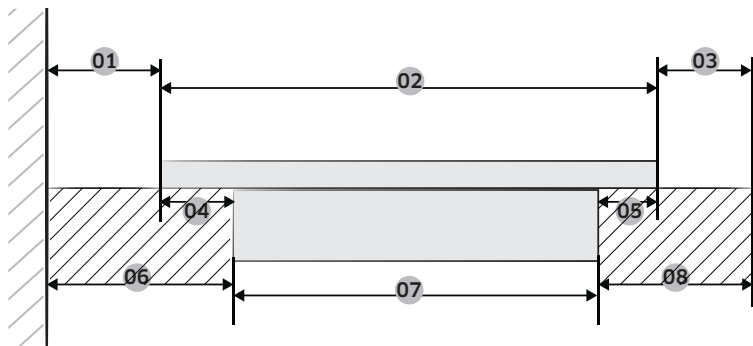

No.	Explanation	Size
01	Distance between wall and Induction	Min 40 mm
02	Size of depth of Induction	520 mm
03	Distance between Induction and end of table	Min 40 mm
04	Distance between glass and case burner	25 mm
05	Distance between glass and case burner	15 mm
06	Distance between wall and case burner.	Min 60 mm
07	Size of depth of case burner	480 mm
08	Distance between case burner and end of table	Min 50 mm

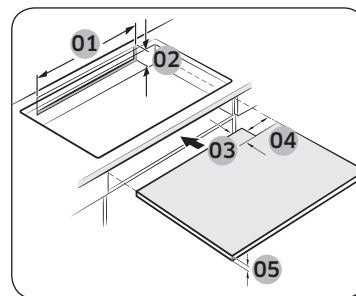

No.	Explanation	Size
01	Width of rear ventilation	Min 550 mm
02	Height of rear ventilation	Min 35 mm
03	Depth of power cord path	Max 65 mm
04	Width of power cord path	Max 100 mm
05	Height of block board	Min 5 mm

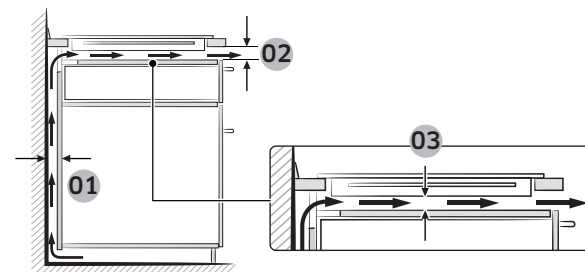

No.	Explanation	Size
01	Size of ventilation	Min 20 mm
02		Min 2 mm
03		Min 20 mm

Parts and features

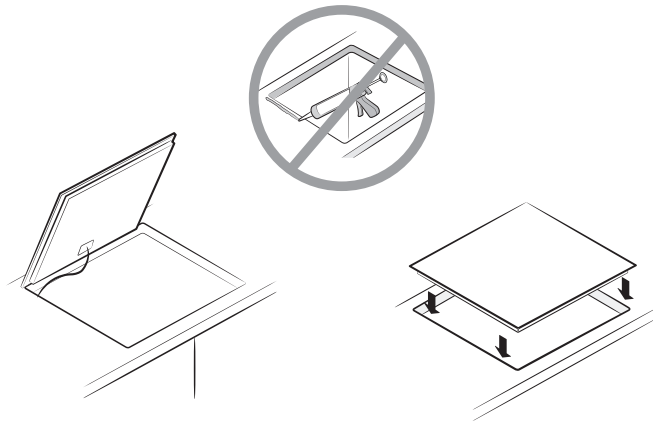
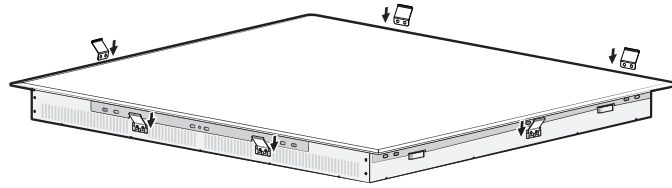

Cooking zones

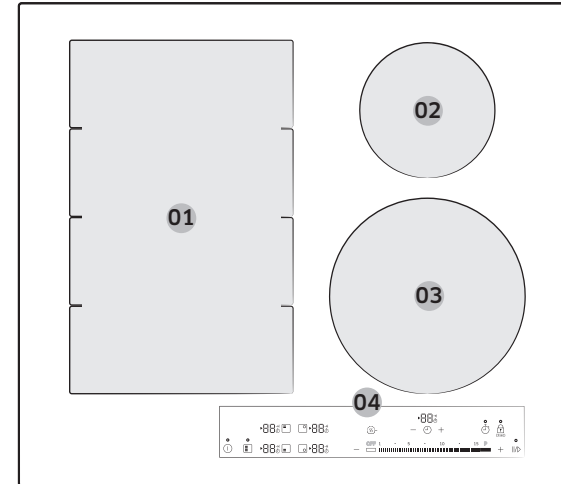

01	Induction Flex zone Plus 3300 W with Power Boost 3600 W
02	Induction cooking zone 1400 W with Power Boost 2000 W
03	Induction cooking zone 2200 W with Power Boost 3200 W
04	Control Panel

Parts and features

Control panel

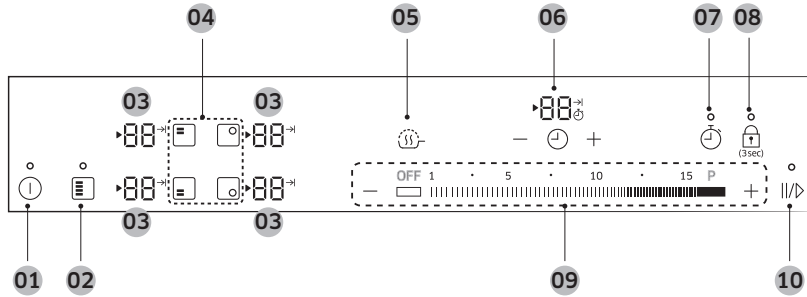

01	On/Off control sensor
02	Flex zone Plus sensor
03	Indicators for heat settings and residual heat
04	Cooking zone sensor
05	Keep warm sensor
06	Timer control sensor and indicator (Count down)
07	Timer control sensor (Count up)
08	Lock control sensor
09	Heat setting sensor
10	Pause&Go sensor

Parts and features

Components

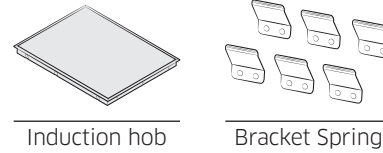

Induction heating

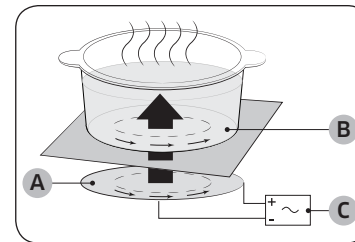

- A. Induction coil
- B. Induced currents
- C. Electronic circuits

- **The Principle of Induction Heating:**
When you place your cookware on a cooking zone and you turn it on, the electronic circuits in your induction hob produce “induced currents” in the bottom of the cookware which instantly raise cookware’s temperature.
- **Greater speed in cooking and frying:**
As the pan is heated directly and not the glass, the efficiency is greater than in other systems because no heat is lost. Most of the energy absorbed is transformed into heat.

The key features of your appliance

- **Ceramic glass cooking surface:** The hob has ceramic, rapid-response cooking zones.
 - **Touch control sensors:** Your appliance is operated using touch control sensors.
 - **Easy cleaning:** The flat, ceramic glass cooktop provides easy cleaning.
 - **On/Off sensor:** The “On/Off” control sensor provides the appliance with a separate mains switch. Touching this sensor switches the power supply on or off completely.
 - **Control and function indicators:** Digital displays and indicator lights provide information about settings and activated functions, as well as the presence of residual heat in the various cooking zones.
 - **Safety shutoff:** A safety shutoff ensures that cooking zones switch off automatically after a period of time if the setting has not been changed.
 - **Power Boost P:** Use this function to heat up the contents of the pan faster than maximum power level 15. (The display will show P.)
 - **Auto Pan-Detection:** Each cooking zone incorporates an automatic pan-detection system, the system is calibrated in order to recognize pans of a diameter just slightly smaller than the cooking zone. Pans must always be placed centrally on each cooking zone. And you should use suitable cookware.
 - **Digital displays:**
 - to 15, P selected heat settings
 - H residual heat (Stay Hot)
 - H residual heat
 - L the child lock is activated
 - message, the touch sensor button has been touched for longer than 8 seconds.
 - I message, when the hob is overheated because of abnormal operation. (example : operation with empty cookware)
 - U, cookware is unsuitable or too small or no cookware has been placed on the cooking zone.
 - **Keep warm** : Use this function to keep cooked food warm. The display will show .
 - **Pause** : Use this function to switch all cooking zones on to the low power setting. (example : to take a telephone call) The display will show .
- **Flex zone Plus sensor** : Use this function to expand cooking zone into complete left side.
 - **Flex zone Plus:** The Flex zone Plus is a large, rectangle-shaped area designed for cooking multiple dishes.
 - **Quick Stop:** This option reduces the step and time it takes to stop cooking by simple one touch.



Parts and features

Safety shutoff

If one of the cooking zones is not switched off or the heat setting is not adjusted after an extended period of time, that particular cooking zone will automatically switch itself off.

Any residual warmth will be indicated with **H**, **H** (for "hot") in the digital displays corresponding to the particular cooking zones.

The cooking zones switch themselves off at the following times.

Heat setting	Switch off
1-3	After 6 hours
4-6	After 5 hours
7-9	After 4 hours
10-15	After 1.5 hours

NOTE

If the Hob is overheated because of abnormal operation, **H** will be displayed. And the Hob will be switched off.

NOTE

If cookware is unsuitable or too small or no cookware has been placed on the cooking zone, **H** will be displayed. And after 1 minute the corresponding cooking zone will be switched off.

NOTE

Should one or more of the cooking zones switch off before the indicated time has elapsed, see the section "Troubleshooting".

Other reasons why a cooking zone will switch itself off

All cooking zones will switch themselves off if liquid boils over and lands on the control panel.

The automatic shutoff will also be activated if you place a damp cloth on the control panel. In both of these instances, the appliance will need to be switched on again using the main **On/Off control** ① sensor after the liquid or the cloth has been removed.

Flex zone Plus

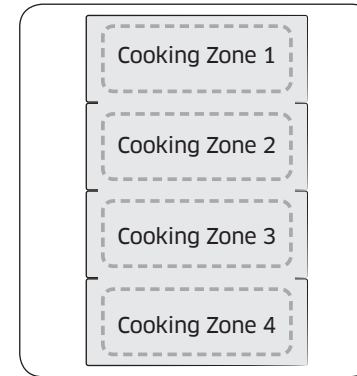

The Flex zone is the large cooking area located on the left side of the hob (see the figure below) that is specially designed to accommodate multiple pots and pans of varying shapes and sizes at once. The Flex zone has four zones that are operated by individual inductors, allowing you to cook regardless of where cookware is placed on a cooking zone.

With Flex zone Plus, you can use a combination of different cooking zones to enlarge the cooking area. See the table below for the corresponding sensor to touch to activate the different combinations.

Cooking Zone	1 burner	2 burner	3 burner	4 burner
1				
2				
3				
4				

NOTE

- When using only one cooking zone, the diameter of the bottom of the cookware must be less than 14 cm.
- The hob may take 5-10 seconds to recognize the position of cookware.
- Noises may occur while the hob recognizes the cookware.
- Do not remove cookware during cooking. For safety purposes, the hob automatically stops if cookware has been removed for more than 5 seconds.

Residual heat indicator

When an individual cooking zone or the hob is turned off, the presence of residual heat is shown with an **H**, **h** (for "hot") in the digital display of the appropriate cooking zones. Even after the cooking zone has been switched off, the residual heat indicator goes out only after the cooking zone has cooled.

You can use the residual heat for thawing or keeping food warm.

⚠ WARNING

As long as the residual heat indicator is illuminated, there is a risk of burns.

⚠ WARNING

If the power supply is interrupted, the **H**, **h** symbol will go out and information about residual heat will no longer be available.

However, it may still be possible to burn yourself. This can be avoided by always taking care when near the hob.

Temperature detection

If for any reason the temperatures on any of the cooking zones were to exceed the safety levels, should this happen then the cooking zone will automatically reduce to a lower power level.

When you have finished using the hob, the cooling fan will continue to run until the hob's electronics has cooled down. And the cooling fan switched itself off depending upon the temperature of the electronics.

Hob use

Initial cleaning

Wipe the ceramic glass surface with a damp cloth and ceramic cooktop glass cleaner.

⚠ WARNING

Do not use caustic or abrasive cleaners. The surface could be damaged.

Cookware for induction cooking zones

The induction hob can only be turned on when cookware with a magnetic base is placed on one of the cooking zones. You can use the following suitable cookware.

Cookware material

Cookware material	Suitable
Steel, Enamelled steel	Yes
Cast iron	Yes
Stainless steel	If appropriately labelled by the manufacturer
Aluminium, Copper, Brass	No
Glass, Ceramic, Porcelain	No

📄 NOTE

Cookware for induction hob is labelled as suitable by the manufacturer.

📄 NOTE

When used on induction cooking zones, cookware may make noises. These noises are normal.

📄 NOTE

Non-stainless steel cookware are less heat-conductive than stainless steel. Using non-stainless steel cookware lengthens cooking time.

Hob use

Suitability test

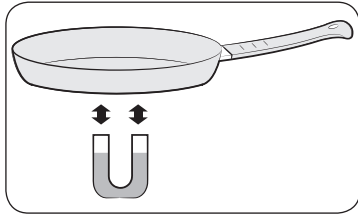

Cookware is suitable for induction cooking, if a magnet sticks to the bottom of the cookware and cookware is labelled as suitable by the cookware manufacturer.

NOTE

Induction cooking may not function properly on nonferrous cookware whose edge doesn't stick to the magnet, or on nonferrous cookware whose bottom is iron-coated.

Size of pans

Induction cooking zones adapt automatically to the size of the bottom of the cookware up to a certain limit. However the magnetic part of the bottom of the cookware must have a minimum diameter depending upon the size of the cooking zone.

Cooking zones	Minimum diameter of the bottom of the cookware
Right Rear Burner (145mm)	100 mm
Right Front Burner (210mm)	140 mm
Front or Rear Flex zone plus	140 mm
Flex zone plus	240 mm (long side dimension), oval, fish kettle

Operating noises

If you can hear.

- **Cracking noise:** cookware is made of different materials.
- **Whistling:** you use more than two cooking zones and the cookware is made of different materials.
- **Humming:** you use high power levels.
- **Clicking:** electric switching occurs.
- **Hissing, Buzzing:** the fan operates.

The noise are normal and do not refer to any defects.

WARNING

Do not use cookware of different size and material.

Using cookware of different sizes or materials may cause noises and vibrations.

NOTE

Using low power levels (1~5) may causing clicking noises.

Using suitable cookware

Better pans produce better results.

- You can recognise good pans by their bases. The base should be as thick and flat as possible.
- When buying new pans, pay particular attention to the diameter of the base. Manufacturers often give only the diameter of the upper rim.
- Do not use pans which have damaged bases with rough edges or burrs. Permanent scratching can occur if these pans are slid across the surface.
- When cold, pan bases are normally bowed slightly inwards (concave). They should never be bowed outwards (convex).
- If you wish to use a special type of pan, for example, a pressure cooker, a simmering pan, or a wok, please observe the manufacturer's instructions.

Energy saving tips

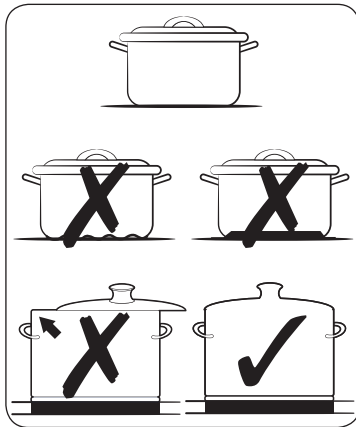

NOTE

You can save valuable energy by observing the following points.

- Always position pots and pans before switching on the cooking zone.
- Dirty cooking zones and pan bases increase power consumption.
- When possible, position the lids firmly on the pots and pans to cover completely.
- Switch the cooking zones off before the end of the cooking time to use the residual heat for keeping foods warm or for thawing.

NOTE

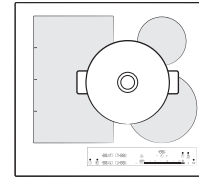

Do not use one piece of cookware on both the left and right cooking zones.

Using the touch control sensors

To operate the touch control sensors, touch the desired panel with the tip of your pointed finger until the relevant displays illuminate or go out, or until the desired function is activated.

Ensure that you are touching only one sensor panel when operating the appliance. If your finger is too flat on the panel, an adjacent sensor may be actuated as well.

Switching the appliance on

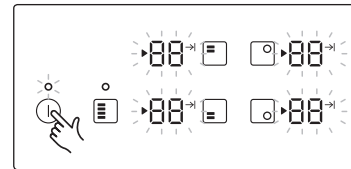

The appliance is switched on using the **On/Off control** ① sensor.

Touch the **On/Off control** ① sensor for approximately 1~2 seconds.

The digital displays will show .

NOTE

After the **On/Off control** ① sensor has been actuated to switch on your appliance, a heat setting must be selected within approximately 20 seconds. Otherwise, the appliance will switch itself off for safety reasons.



Hob use

Select cooking zone and heat setting

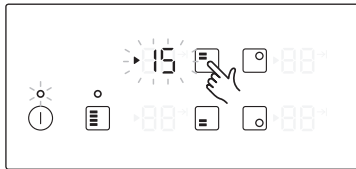

1. For selecting the cooking zone, touch the corresponding cooking zone's sensor.

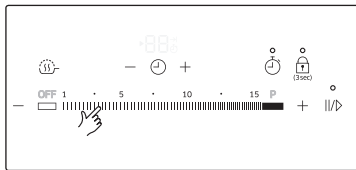

2. For setting and adjusting the power level, touch the Heat setting sensor.

NOTE

The default level is set to 15 when selecting the cooking zone.

NOTE

If more than one sensor is pressed for longer than 8 seconds, will show in the heat setting display.

Switching the appliance off

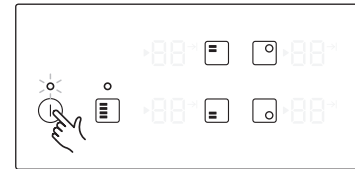

To completely switch off the appliance, use the **On/Off control** sensor. Touch the **On/Off control** sensor for approximately 1~2 seconds.

NOTE

After switching off a single cooking zone or the entire cooking surface, the presence of residual heat will be indicated in the digital displays of the corresponding cooking zones in the form of an two steps for "hot". The temperature is lowered, will be disappeared.

Quick stop

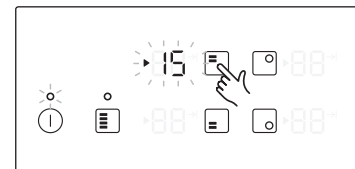

To switch off a cooking zone, press the cooking zone sensor during 2 seconds.

NOTE

Flex zone Plus sensor dose not operate quick stop function.



Using the child safety lock

You can use the child safety lock to safeguard against unintentionally turning on a cooking zone and activating the cooking surface. Also the control panel, with the exception of the **On/Off control** (ⓘ) sensor (Only turn off control), can be locked in order to prevent the settings from being changed unintentionally, for example, by wiping over the panel with a cloth.

Switching the child safety lock On/Off

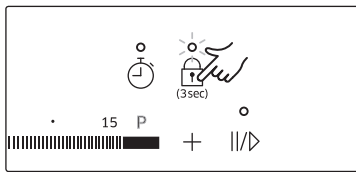

1. Touch the **Lock control** (ⓘ) sensor for approximately 3 seconds. An acoustic signal will sound as confirmation.

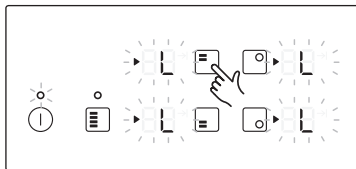

2. Touch any control sensor. **L** will appear in the displays, indicating the child safety lock has been activated.
3. For switching the child safety lock off, touch the **Lock control** (ⓘ) sensor again for 3 seconds. An acoustic signal will sound as confirmation.

NOTE

Regardless of power on/off, child lock is activated.

NOTE

You can use Lock control during cooking. In this case, To turn off the burner, you should operate lock off or Power OFF.

Timer (Count down)

Using the timer as a safety shutoff:

If a specific time is set for a cooking zone, the cooking zone will shut itself off once this period of time has elapsed. This function can be used for multiple cooking zones simultaneously.

Setting the safety shutoff

The cooking zone(s) for which you want to apply the safety shutoff must be switched on.

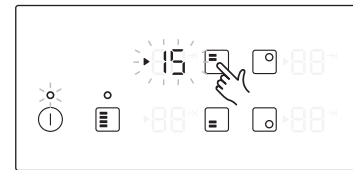

1. After switched on, press the corresponding cooking zone to activate the flash signal for the corresponding cooking zone display.



2. Press **Timer control** (ⓘ) sensor. The number 10 will be displayed above the timer display.

NOTE

The default setting of the timer is 10.

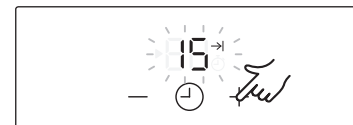

3. Use the **Timer setting sensor** (+ or -) to set the desired amount of time, for example, 15 minutes, after which the cooking zone will automatically switch itself off. The safety shutoff is now activated.

NOTE

The timer can be set from 1 to 99.

Hob use



4. To cancel the timer settings, select the target burner and hold down the **Timer control** ⌚ sensor for 2 seconds. This will cancel the burner's timer settings with a beep. If holding down the **Timer control** ⌚ sensor for 2 seconds without selecting a burner, this will cancel the timer settings of the last changed burner.

To display the time remaining for any of the cooking zones, use the **Timer control** ⌚ sensor after select burner.

The corresponding control indicator will begin to blink slowly.

The settings are reset using the **Timer setting sensor** (+ or -). After the set period of time has elapsed, the cooking zone automatically switches itself off, an acoustic signal sounds as confirmation and the timer display indicates.

NOTE

To change the settings quicker, touch and hold any of the + or - control sensors until the desired value is reached.

Timer (Count up)

For the count up timer to be used, the appliance must be switched on but all the cooking zones must be not use timer as a safety shutoff.

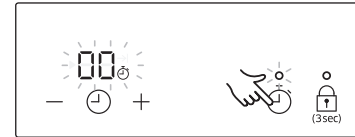

1. Touch the **Timer control** ⌚ sensor.  will appear in the timer display.

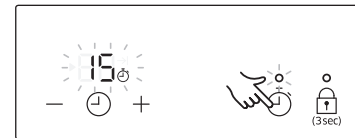

2. The count up timer function becomes active and the display numbers increase over time. To cancel the timer settings, hold down the **Timer control** ⌚ sensor for 2 seconds.
3. To stop the timer, touch the **Timer control** ⌚ sensor.

Using keep warm

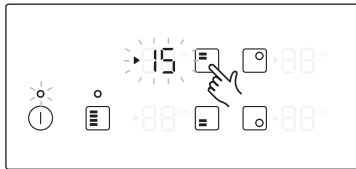

1. Use this function to Keep cooked food Warm. Touch the corresponding cooking zone's sensor.



2. Touch the **Keep warm**  sensor.

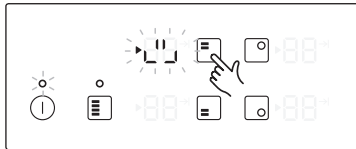

3. The burner display will be changed Touch again to turn off the burner.

Power boost control

The **Power Boost P** function makes additional power available to the each cooking zones. (example : bring a large volume of water to the boil)

Cooking zones	Max Boost time
145 mm	10 min
210 mm	10 min
Front or Rear Flex Plus	10 min
Complete Flex Plus	5 min

After these times, the cooking zones automatically return to power level **15**.

NOTE

In certain circumstances, the Power boost function may be deactivated automatically to protect the internal electronic components of the hob. For example, It is impossible to output max power on Flex zone rear and Flex zone front at the same time.



Hob use

Power management

The cooking zones have a maximum power available to them. If this power range is exceeded by switching on the **Power Boost P** function, Power Management automatically reduced the heat setting of cooking zone.

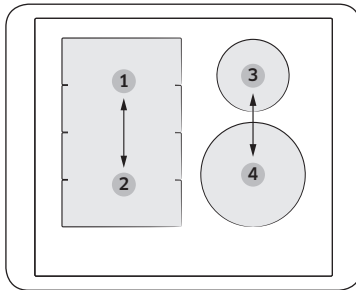

- No.1 and No.2 is paired
 - No3. and No.4 is paired
- The indicator for this cooking zone alternates for some seconds between the set heat setting and the maximum possible heat setting. After then, the indicator changes from the set heat setting to maximum possible heat setting.

Pause

The **Pause** ||/> function simultaneously switches all cooking zones that are switched on to the low power setting and then back to the heat setting that was previously set. This function can be used to briefly interrupt and then continue the cooking process e.g. to take a telephone call.

When the **Pause** ||/> function is activated, all touch sensors except for the **Pause** ||/>, **Lock** ⏹ and the **On/Off control** ⏻ sensors are disabled. To resume cooking, touch the **Pause** ||/> sensor again.

	Control Panel	Display
To Switch On	Touch Pause />	⏻ 2
To Switch Off	Touch Pause />	Return to previous power level

Flex control

The Flex function can operate complete left side cooking zone for using large size cookware. (example : oval cookware, fish kettle)

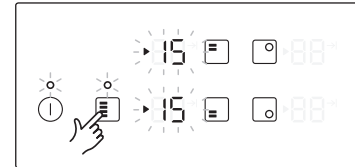

1. Touch the **Flex zone Plus** sensor.

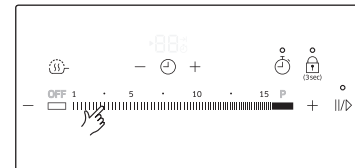

2. For setting and adjusting the power level, touch the Heat setting sensor.

NOTE

- If you touch the **Flex zone plus** sensor during operating, Flex zone plus function will be off.
- If you touch **Flex zone Plus** sensor while each burner operation different level, burner set at a high level.
- Touching the **Flex zone Plus** sensor while the Flex zone is operating turns off the Flex zone.
- When moving or adding cookware to a new Flex zone Plus, cancel the current operation, and then press the corresponding sensor to activate the cooking zone.



Sound on/off



1. Touch the **On/Off control**  sensor for approximately 1~2 seconds.

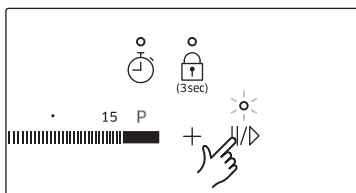

2. Touch the **Pause**  sensor for 3 seconds within 10 seconds after Power On.

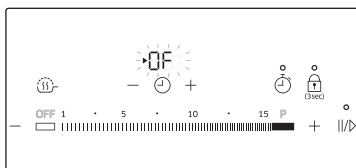

3. Sound will OFF and  will show in the display.

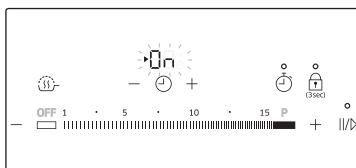

4. To change Sound setting, repeat No1 and No2 procedure. Sound will ON and  will show in the display.

NOTE

Turn on the Power, It is not possible to operate sound **on/off** control after 10 seconds.

Suggested settings for cooking specific foods

The figures in the table below are guidelines. The heat settings required for various cooking methods depend on a number of variables, including the quality of the cookware being used and the type and amount of food being cooked.

Switch setting	Cooking method	Examples for Use
14-15	Warming Sautéing Frying	Warming large amounts of liquid, boiling noodles, searing meat, browning goulash, braising meat
8-11	Intensive Frying	Steak, sirloin, hash browns, sausages, pancakes / griddle cakes
7-10	Frying	Schnitzel / chops, liver, fish, rissoles, fried eggs
5-7	Boiling	Cooking up to 1.5 l liquid, potatoes, vegetables
2-4	Steaming Stewing Boiling	Steaming and stewing of small amounts of vegetables, boiling rice and milk dishes
1-2	Melting	Melting butter, dissolving gelatine, melting chocolate

NOTE

The heat settings indicated in the table above are provided only as guidelines for your reference.

NOTE

You will need to adjust the heat settings according to specific cookware and foods.

Cleaning and care

Hob

⚠ WARNING

Cleaning agents must not come into contact with a heated ceramic glass surface: All cleaning agents must be removed with adequate amounts of clean water after cleaning because they can have a caustic effect when the surface becomes hot. Do not use any aggressive cleaners such as grill or oven sprays, scouring pads or abrasive pan cleaners.

📖 NOTE

Clean the ceramic glass surface after each use when it is still warm to the touch. This will prevent spillage from becoming burnt onto the surface. Remove scales, watermarks, fat drippings and metallic discolouration with the use of a commercially available ceramic glass or stainless steel cleaner.

Light soiling

1. Wipe the ceramic glass surface with a damp cloth.
2. Rub dry with a clean cloth. Remnants of cleaning agent must not be left on the surface.
3. Thoroughly clean the entire ceramic glass cooking surface once a week with a commercially available ceramic glass or stainless steel cleaner.
4. Wipe the ceramic glass surface using adequate amounts of clean water and rub dry with a clean lint - free cloth.

Stubborn soiling

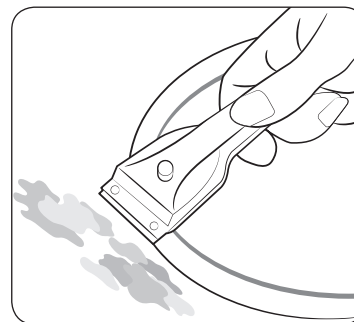

1. To remove food that has boiled over and stubborn splashes, use a glass scraper.
2. Place the glass scraper at an angle to the ceramic glass surface.
3. Remove soiling by scraping with the blade.

📖 NOTE

Glass scrapers and ceramic glass cleaners are available from specialty retailers.

Problem dirt

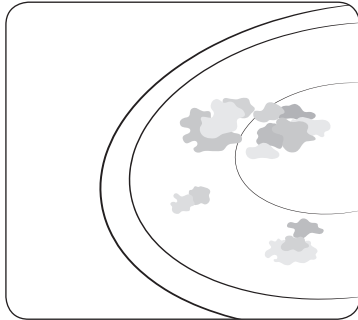

1. Remove burnt-on sugar, melted plastic, aluminium foil or other materials with a glass scraper immediately and while still hot.

WARNING

There is a risk of burning yourself when the glass scraper is used on a hot cooking zone:

2. Clean the hob as normal when it has cooled down. If the cooking zone on which something has melted has been allowed to cool, warm it up again for cleaning.

NOTE

Scratches or dark blemishes on the ceramic glass surface, caused, for example, by a pan with sharp edges, cannot be removed. However, they do not impair the function of the hob.

Hob frame (option)

WARNING

Do not use vinegar, lemon juice or scale remover on the hob frame; otherwise dull blemishes will appear.

1. Wipe the frame with a damp cloth.
2. Moisten dried debris with a wet cloth. Wipe and rub dry.

To avoid damaging your appliance

- Do not use the hob as a work surface or for storage.
- Do not operate a cooking zone if there is no pan on the hob or if the pan is empty.
- Ceramic glass is very tough and resistant to temperature shock, but it is not unbreakable. It can be damaged by a particularly sharp or hard object dropping onto the hob.
- Do not place pans on the hob frame. Scratching and damage to the finish may occur.
- Avoid spilling acidic liquids, for example, vinegar, lemon juice and descaling agents, onto the hob frame, since such liquids can cause dull spots.
- If sugar or a preparation containing sugar comes into contact with a hot cooking zone and melts, it should be cleaned off immediately with a kitchen scraper while it is still hot. If allowed to cool, it may damage the surface when removed.
- Keep all items and materials that could melt, for example, plastics, aluminium foil and oven foils, away from the ceramic glass surface. If something of this nature melts onto the hob, it must be removed immediately with a scraper.



Warranty and service

FAQs and troubleshooting

A fault may result from a minor information that you can correct yourself with the help of the following instructions. Do not attempt any further repairs if the following instructions do not help in each specific case.

⚠ WARNING

Repairs to the appliance are to be performed only by a qualified service technician. Improperly effected repairs may result in considerable risk to the user. If your appliance needs repair, please contact your customer service centre.

Problem	Possible cause	Solution
What should I do if the cooking zones are not functioning?	<ul style="list-style-type: none"> The fuse in the house wiring is intact. 	<ul style="list-style-type: none"> If the fuses trip a number of times, call an authorised electrician.
What should I do if the cooking zones will not switch on?	<ul style="list-style-type: none"> The On/Off sensor was accidentally actuated. The control panel is partially covered by a damp cloth or liquid. 	<ul style="list-style-type: none"> The appliance is properly switched on. Clean the control panel.
What should I do if the display except for  ,  the residual warmth indicator suddenly disappears?	<ul style="list-style-type: none"> The On/Off sensor was accidentally actuated. The control panel is partially covered by a damp cloth or liquid. 	<ul style="list-style-type: none"> The appliance is properly switched on. Clean the control panel.
What should I do if, after the cooking zones have been switched off, residual warmth is not indicated in the display	<ul style="list-style-type: none"> The cooking zone was only briefly used and therefore did not become hot enough. 	<ul style="list-style-type: none"> If the cooking zone is hot, please call a local service center

Information code	Possible cause	Solution
C0	Check the Auto Cook sensor.	Restart the appliance using the Power button. If the problem continues, disconnect power for more than 30 seconds. Then, restart the appliance and try again. If the problem still continues, contact a local service center.
C1	The temperature is sensed higher than specified.	
C2	Check the Auto Cook sensor.	
A2	The DC Motor fails to operate because of problems with the PCB or wiring, or electrical disturbance on the motor blade.	Then, restart the appliance and try again. If the problem still continues, contact a local service center.
d0	The sensor is pressed for more than 8 seconds.	Check if the sensor pad is wet or pressed. If the problem continues, restart the appliance using the Power button. If the problem still continues, contact a local service center.
F0	Communications between main and sub PCBs fail.	Restart the appliance using the Power button. If the problem continues, disconnect power for more than 30 seconds. Then, restart the appliance. If the problem still continues, contact a local service center.
F2	The touch-enabled IC communicates abnormally.	

What should I do if the cooking zone will not switch on or off?

This could be due to one of the following possibilities:

- The control panel is partially covered by a damp cloth or liquid.
- The child safety lock is on and display “L”.

What should I do if the display is illuminated?

Check for the following:

- The control panel is partially covered by a damp cloth or liquid. To reset, press the **On/Off** control sensor.
- If liquid has overflowed on control panel, please wipe the liquid.

What should I do if the display is illuminated?

Check for the following:

- The hob is overheated because of abnormal operation.
- After hob is cooled down, press the **On/Off** control sensor for resetting.

What should I do if the display is illuminated?

Check for the following:

- Cookware is unsuitable or too small or no cookware has been placed on the cooking zone.
- If you use suitable cookware, displayed message will automatically disappear.

What should I do if the cooling fan runs after the hob is turned off?

Check for the following:

- When you have finished using the hob, the cooling fan runs by itself for cooling down.
- After the hob's electronics has cooled down or elapsed max time (10 minutes) the cooling fan will be turned off.
- If you request a service call because of an information made in operating the appliance, the visit from the customer service technician may incur a charge even during the warranty period.

Service

Before calling for assistance or service, please check the section “Troubleshooting”. If you still need help, follow the instructions below.

Is it a technical fault?

If so, please contact your customer service centre.

Always prepare in advance for the discussion. This will ease the process of diagnosing the problem and also make it easier to decide if a customer service visit is necessary.

Please take note of the following information.

- What form does the problem take?
- Under what circumstances does the problem occur?

When calling, please know the model and serial number of your appliance. This information is provided on the rating plate as follows:

- Model description
- S/N code (15 digits)

We recommend that you record the information here for easy reference.

- Model:
- Serial number:

When do you incur costs even during the warranty period?

- If you could have remedied the problem yourself by applying one of the solutions provided in the section “Troubleshooting”.
- If the customer service technician has to make several service calls because he was not provided with all of the relevant information before his visit and as a result, for example, has to make additional trips for parts. Preparing for your phone call as described above will save you the cost of these trips.

Technical data

Technical data

Appliance dimensions	Width	600 mm
	Depth	520 mm
	Height	56 mm
Worktop cut - out dimensions	Width	560 mm
	Depth	490 mm
	Height	72 mm
	Corner radius	3 mm
Connection voltage		220 - 240 V ~ 50 / 60 Hz
Maximum connected load power		7.2 kW
Weight	Net	13.2 kg
	Gross	16.0 kg

Cooking zones

Position	Diameter	Power
Right Front	210 mm	2200 W / Boost 3200 W
Right Rear	145 mm	1400 W / Boost 2000 W
Flex Plus Front	-	1800 W / Boost 2600 W
Flex Plus Rear	-	1800 W / Boost 2600 W
Flex Plus Center	-	1800 W / Boost 3000 W
Complete Flex Plus	-	3300 W / Boost 3600 W

Product information

Supplier's name	Samsung Electronics co. Ltd.
Model identification	NZ64K7757BK
Type of hob	Built-In
Heating technology	Induction cooking zones and cooking area
Number of cooking zones and/or area	3
For circular cooking zones or area: diameter of useful surface area per electric heated cooking zone (Ø)	21.0 cm, 14.5 cm
For non-circular cooking zones or area: length and width of useful surface area per electric heated cooking zone or area (L x W)	24.0 x 38.0 cm
Energy consumption per cooking zone or area calculated per kg (EC _{electric cooking})	Ø 21.0 cm : 184.2 Wh/kg
	Ø 14.5 cm : 191.3 Wh/kg
	24.0 x 38.0 cm : 199.0 Wh/kg
Energy consumption for the hob calculated per kg (EC _{electric hob})	191.5 Wh/kg

* Data determined according to standard EN 60350-2 and Commission Regulations (EU) No 66/2014.

Energy saving tips

- Always position pots and pans before switching on the cooking zone.
- Dirty cooking zones and pan bases increase power consumption.
- Using a pressure cooker reduces cooking time.

Memo

Memo

Memo

Please be advised that the Samsung warranty does NOT cover service calls to explain product operation, correct improper installation, or perform normal cleaning or maintenance.

QUESTIONS OR COMMENTS?

COUNTRY	CALL	OR VISIT US ONLINE AT
AUSTRIA	0800-SAMSUNG (0800-7267864) [Only for Premium HA] 0800-366661 [Only for Dealers] 0810-112233*	www.samsung.com/at/support
BELGIUM	02-201-24-18	www.samsung.com/be/support (Dutch) www.samsung.com/be_fr/support (French)
DENMARK	70 70 19 70	www.samsung.com/dk/support
FINLAND	030-6227 515	www.samsung.com/fi/support
FRANCE	01 48 63 00 00	www.samsung.com/fr/support
GERMANY	0180 6 SAMSUNG bzw. 0180 6 7267864* (*0,20 €/Anruf aus dem dt. Festnetz, aus dem Mobilfunk max. 0,60 €/Anruf)	www.samsung.com/de/support
ITALIA	800-SAMSUNG (800.7267864)	www.samsung.com/it/support
CYPRUS	8009 4000 only from landline, toll free	www.samsung.com/gr/support
GREECE	80111-SAMSUNG (80111 726 7864) only from land line (+30) 210 6897691 from mobile and land line	
LUXEMBURG	261 03 710	www.samsung.com/be_fr/support
NETHERLANDS	0900-SAMSUNG (0900-7267864) (€ 0,10/Min)	www.samsung.com/nl/support
NORWAY	815 56480	www.samsung.com/no/support
PORTUGAL	808 20 7267	www.samsung.com/pt/support
SPAIN	0034902172678	www.samsung.com/es/support
SWEDEN	0771 726 7864 (0771-SAMSUNG)	www.samsung.com/se/support
SWITZERLAND	0800 726 78 64 (0800-SAMSUNG)	www.samsung.com/ch/support (German) www.samsung.com/ch_fr/support (French)
UK	0330 SAMSUNG (7267864)	www.samsung.com/uk/support
EIRE	0818 717100	www.samsung.com/ie/support



DG68-00790A-00