

HT-H7500WM

HT-H7750WM

Blu-ray™

Home Entertainment System  
user manual

imagine the possibilities

Thank you for purchasing this Samsung product.  
To receive more complete service,  
please register your product at  
[www.samsung.com/register](http://www.samsung.com/register)

**SAMSUNG**

# Safety Information

## CAUTION

### RISK OF ELECTRIC SHOCK DO NOT OPEN

CAUTION: TO REDUCE THE RISK OF ELECTRIC SHOCK, DO NOT REMOVE THE COVER (OR BACK). THERE ARE NO USER SERVICEABLE PARTS INSIDE. REFER ALL SERVICING TO QUALIFIED PERSONNEL.



This symbol indicates that high voltage is present inside. It is dangerous to make any kind of contact with any internal part of this product.



This symbol indicates that important literature concerning operation and maintenance has been included with this product.

- The slots and openings in the cabinet and in the back or bottom are provided for necessary ventilation. To ensure reliable operation of this apparatus, and to protect it from overheating, these slots and openings must never be blocked or covered.
  - Do not place this apparatus in a confined space, such as a bookcase, or built-in cabinet, unless proper ventilation is provided.
  - Do not place this apparatus near or over a radiator or heat register, or where it is exposed to direct sunlight.
  - Do not place vessels (vases etc.) containing water on this apparatus. A water spill can cause a fire or electric shock.
- Do not expose this apparatus to rain or place it near water (near a bathtub, washbowl, kitchen sink, or laundry tub, in a wet basement, or near a swimming pool, etc.). If this apparatus accidentally gets wet, unplug it and contact an authorized dealer immediately.
- This apparatus uses batteries. In your community, there might be environmental regulations that require you to dispose of these batteries properly. Please contact your local authorities for disposal or recycling information.
- Do not overload wall outlets, extension cords or adaptors beyond their capacity, since this can result in fire or electric shock.
- Route power-supply cords so that they are not likely to be walked on or pinched by items placed on or against them. Pay particular attention to cords at the plug end, at wall outlets, and the point where they exit from the apparatus.
- To protect this apparatus from a lightning storm, or when it is left unattended and unused for long periods of time, unplug it from the wall outlet and disconnect the antenna or cable system. This will prevent damage to the set due to lightning and power line surges.
- Before connecting the AC power cord to the DC adaptor outlet, make sure the voltage designation of the DC adaptor corresponds to the local electrical supply.
- Never insert anything metallic into the open parts of this apparatus. Doing so may create a danger of electric shock.
- To avoid electric shock, never touch the inside of this apparatus. Only a qualified technician should open this apparatus.
- Make sure to plug the power cord in until it is firmly seated. When unplugging the power cord from a wall outlet, always pull on the power cord's plug. Never unplug by pulling on the power cord. Do not touch the power cord with wet hands.
- If this apparatus does not operate normally - in particular, if there are any unusual sounds or smells coming from it - unplug it immediately and contact an authorized dealer or service centre.
- Maintenance of Cabinet.
  - Before connecting other components to this product, be sure to turn them off.
  - If you move your product suddenly from a cold place to a warm place, condensation may occur on the operating parts and lens and cause abnormal disc playback. If this occurs, unplug the product, wait for two hours, and then connect the plug to the power outlet. Then, insert the disc, and try to play back again.
- Be sure to pull the power plug out of the outlet if the product is to remain unused or if you are leaving the house for an extended period of time (especially when children, elderly, or disabled people will be left alone in the house).
  - Accumulated dust can cause an electric shock, an electric leakage, or a fire by causing the power cord to generate sparks and heat or the insulation to deteriorate.
- Contact an authorized service centre for information if you intend to install your product in a location with heavy dust, high or low temperatures, high humidity, chemical substances, or where it will operate 24 hours a day such as in an airport, a train station, etc. Failing to do so may lead to serious damage of your product.

- Use only a properly grounded plug and wall outlet.
  - An improper ground may cause electric shock or equipment damage. (Class I Equipment only.)
- To turn this apparatus off completely, you must disconnect it from the wall outlet. Consequently, the wall outlet and power plug must be readily accessible at all times.
- Do not allow children to hang on the product.
- Store the accessories (battery, etc.) in a location safely out of the reach of children.
- Do not install the product in an unstable location such as a shaky self, a slanted floor, or a location exposed to vibration.
- Do not drop or strike the product. If the product is damaged, disconnect the power cord and contact a service centre.
- To clean this apparatus, unplug the power cord from the wall outlet and wipe the product using a soft, dry cloth. Do not use any chemicals such as wax, benzene, alcohol, thinners, insecticide, air fresheners, lubricants, or detergent. These chemicals can damage the appearance of the product or erase the printing on the product.
- Do not expose this apparatus to dripping or splashing. Do not put objects filled with liquids, such as vases on the apparatus.
- Do not dispose of batteries in a fire.
- Do not plug multiple electric devices into the same wall socket. Overloading a socket can cause it to overheat, resulting in a fire.
- There is danger of an explosion if you replace the batteries used in the remote with the wrong type of battery. Replace only with the same or equivalent type.

**WARNING :**

- TO PREVENT THE SPREAD OF FIRE, KEEP CANDLES AND OTHER ITEMS WITH OPEN FLAMES AWAY FROM THIS PRODUCT AT ALL TIMES.



**CLASS 1 LASER PRODUCT**

This product is classified as a CLASS 1 LASER product. Use of controls, adjustments or performance of procedures other than those specified herein may result in hazardous radiation exposure.

**CAUTION :**

- INVISIBLE LASER RADIATION WHEN OPEN AND INTERLOCKS DEFEATED, AVOID EXPOSURE TO BEAM.

|          |               |
|----------|---------------|
| CLASS 1  | LASER PRODUCT |
| KLASSE 1 | LASER PRODUKT |
| LUOKAN 1 | LASER LAITE   |
| KLASS 1  | LASER APPARAT |
| PRODUCTO | LÁSER CLASE 1 |

**3D Precautions**

**IMPORTANT HEALTH AND SAFETY INFORMATION FOR 3D PICTURES.**

Read and understand the following safety information before using the 3D function.

- Some viewers may experience discomfort while viewing 3D TV such as dizziness, nausea, and headaches. If you experience any such symptom, stop viewing 3D TV, remove the 3D Active Glasses, and rest.
- Watching 3D images for an extended period of time may cause eye strain. If you feel eye strain, stop viewing 3D TV, remove your 3D Active Glasses, and rest.
- A responsible adult should frequently check on children who are using the 3D function. If there are any reports of tired eyes, headaches, dizziness, or nausea, have the child stop viewing 3D TV and rest.
- Do not use the 3D Active Glasses for other purposes (such as general eyeglasses, sunglasses, protective goggles, etc.)
- Do not use the 3D function or 3D Active Glasses while walking or moving around. Using the 3D function or 3D Active Glasses while moving around may cause you to bump into objects, trip, and/or fall, and cause serious injury.
- If you want to enjoy 3D content, connect a 3D device (3D compliant AV receiver or TV) to the product's HDMI OUT port using a high-speed HDMI cable. Put on 3D glasses before playing the 3D content.
- The product outputs 3D signals only through an HDMI cable connected to the HDMI OUT port.
- The video resolution in 3D play mode is fixed to the resolution of the original 3D video. You can not change the resolution.
- Some functions such as BD Wise, screen size adjustment, and resolution adjustment may not operate properly in 3D play mode.
- You must use a high-speed HDMI cable for proper output of the 3D signal.
- Stay at least three times the width of the screen from the TV when watching 3D images. For example, if you have a 46 inch screen, stay 3.5 meters from the screen.
- Place the 3D video screen at eye level for the best 3D picture.
- When the product is connected to some 3D devices, the 3D effect may not function properly.
- This product does not convert 2D content into 3D.
- "Blu-ray 3D" and "Blu-ray 3D" logo are trademarks of the Blu-ray Disc Association.

# Contents

## GETTING STARTED

- 5 Accessories
- 5 Speaker Components
- 6 Front Panel
- 7 Rear Panel
- 8 Remote Control

## CONNECTIONS

- 9 Connecting the Speakers
- 12 Attaching the Toroidal Ferrite Core to the Power Cord of the Wireless Receiver Module (SWA-6000)
- 13 Connecting to a TV and External Devices
- 14 Connecting to a Network Router

## SETTINGS

- 15 The Initial Settings Procedure
- 15 The Home Screen at a Glance
- 16 Accessing the Settings Screen
- 16 Settings Menu Functions
- 22 Network Setup
- 24 Wi-Fi Direct
- 25 Upgrading Software

## PLAYING CONTENT

- 27 Playing Commercial Discs
- 27 Playing Multimedia Files
- 29 Controlling Video Playback
- 32 Controlling Music Playback
- 37 Using Bluetooth
- 40 Playing Photo Contents
- 41 Listening to the Radio
- 42 Using the Special Effects Remote Control Buttons

## NETWORK SERVICES

- 43 Logging In to Your Samsung Account
- 43 Adding a Credit Card
- 43 Before Using FILMS AND TV SHOWS or SAMSUNG APPS
- 44 Using FILMS AND TV SHOWS
- 45 Using SAMSUNG APPS
- 47 Screen Mirroring
- 47 Using the Web Browser
- 50 Linking your Internet Service Accounts to the Product
- 50 BD-LIVE™

## APPENDIX

- 51 Additional Information
- 52 Disk and Format Compatibility
- 59 Troubleshooting
- 62 Specifications
- 64 Licences

## Wiring the Main Power Supply Plug (UK Only)

**IMPORTANT NOTICE :** The mains lead on this equipment is supplied with a moulded plug incorporating a fuse. The value of the fuse is indicated on the pin face of the plug and if it requires replacing, a fuse approved to BS1362 of the same rating must be used. Never use the plug with the fuse cover removed. If the cover is detachable and a replacement is required, it must be of the same colour as the fuse fitted in the plug. Replacement covers are available from your dealer. If the fitted plug is not suitable for the power points in your house or the cable is not long enough to reach a power point, you should obtain a suitable safety approved extension lead or consult your dealer for assistance. However, if there is no alternative to cutting off the plug, remove the fuse and then safely dispose of the plug. Do not connect the plug to a mains socket as there is a risk of shock hazard from the bared flexible cord. Never attempt to insert bare wires directly into a mains socket. A plug and fuse must be used at all times.

**IMPORTANT :** The wires in the mains lead are coloured in accordance with the following code:- BLUE = NEUTRAL BROWN = LIVE As these colours may not correspond to the coloured markings identifying the terminals in your plug, proceed as follows:-The wire coloured BLUE must be connected to the terminal marked with the letter N or coloured BLUE or BLACK. The wire coloured BROWN must be connected to the terminal marked with the letter L or coloured BROWN or RED.

**IMPORTANT :** DO NOT CONNECT EITHER WIRE TO THE EARTH TERMINAL WHICH IS MARKED WITH LETTER E OR BY THE EARTH SYMBOL , OR COLOURED GREEN OR GREEN AND YELLOW.

# Getting Started

- Figures and illustrations in this User Manual are provided for reference only and may differ from actual product appearance.
- An administration fee may be charged if either
  - a. an engineer is called out at your request and there is no defect in the product (i.e. where you have failed to read this user manual)
  - b. you bring the unit to a repair centre and there is no defect in the product (i.e. where you have failed to read this user manual).
- The amount of such administration charge will be advised to you before any work or home visit is carried out.

Check the box for the accessories and speaker components listed or shown below.

## Accessories







- Remote Control
- Lithium Battery
- User Manual

|   |   |   |   |
|---|---|---|---|
|  |  | <br>(For Power cord) |  |
| Power Cable   | FM Antenna  | Toroidal Ferrite Core   | Soft Cloth  |

**!** **WARNING, DO NOT INGEST BATTERY, CHEMICAL BURN HAZARD,**  
 [The remote control supplied with] This product contains a coin/button cell battery.  
 If the coin/button cell battery is swallowed, it can cause severe internal burns in just 2 hours and can lead to death. Keep new and used batteries away from children. If the battery compartment does not close securely, stop using the product and keep it away from children. If you think batteries might have been swallowed or placed inside any part of the body, seek immediate medical attention.









## Speaker Components

HT-H7500WM - 5.1CH

|   |   |   |   |   |
|---|---|---|---|---|
|  |  |  |  |  |
| Front x 2   | Surround x 2  | Centre  | Subwoofer   | Wireless Receiver Module (SWA-6000)   |
|   |   |  |   |   |
|   |   | Speaker Cable x 6   |   |   |

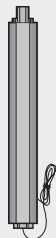
# Getting Started

HT-H7750WM - 7.1CH

|   |   |   |   |   |
|---|---|---|---|---|
|  |  |  |  |   |
| Speaker Cable x 2   | Screw (5x20) x 16   | Stand Base x 4  | Centre  |   |
|  |  |  |  |  |
| Front/<br>Front Top x 2   | Stand x 4   | Surround x 2  | Subwoofer   | Wireless Receiver<br>Module (SWA-6000)  |

## Front Panel

### DISPLAY ICONS

|    |            |     |                |    |            |
|----|------------|-----|----------------|----|------------|
| F. | FUNCTION   | ■   | STOP           | ▶▶ | PLAY/PAUSE |
| ▲  | OPEN/CLOSE | - + | VOLUME CONTROL | ⏻  | POWER      |

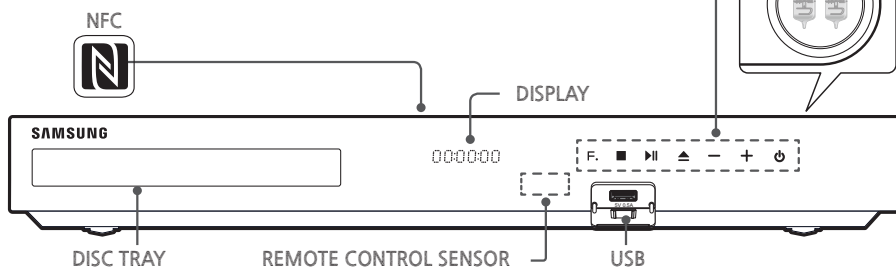

- Cellular phones or mobile devices placed near the vacuum tube amp or electronic products placed on the top of the product can cause audio noise or distortion.
- When the product is on, do not let children touch the product's surface. It will be hot.
- To upgrade the product's software through the USB jack, you must use a USB flash drive.

- 📌 When the product displays a Blu-ray Disc menu, you cannot start the movie by pressing the **▶||** button on the product or the remote. To play the movie, you must select Play Movie or Start in the disc menu, and then press the **OK** button.
- 📌 If you are using the Internet or are playing content from a USB device on your TV through the home cinema, you cannot select the **BD/DVD** mode with the **SOURCE** button. To select the **BD/DVD** mode, exit the Internet or stop the content you are playing on the TV, and then select the **BD/DVD** mode.
- 📌 To use the **NFC** function, tag the compatible Bluetooth source device to the **N** on the top of the product (See page 39).

## Rear Panel

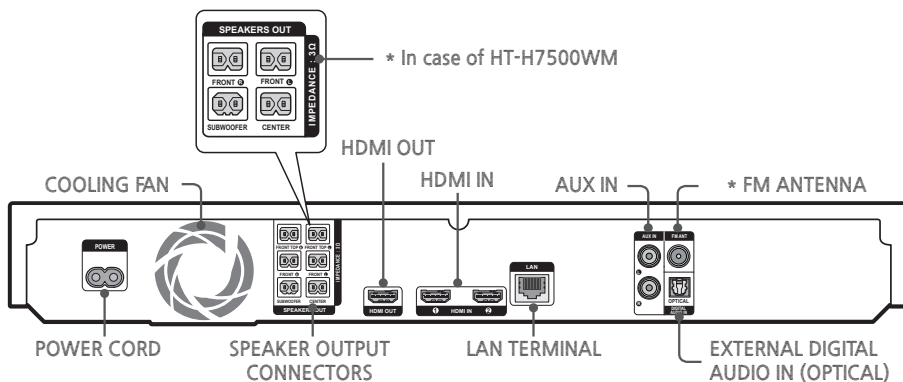

### \* Connecting the FM Antenna

1. Connect the supplied FM antenna to the FM ANT Jack.
  2. Slowly move the antenna wire around until you find a location where reception is good, then fasten it to a wall or other rigid surface.
- 📌 Maintain a minimum of 10 cm of clear space on all sides of the home cinema to ensure adequate ventilation. Do not obstruct the cooling fan or ventilation holes.
  - 📌 This product does not receive AM broadcasts.

# Getting Started

## Remote Control

### Tour of the Remote Control

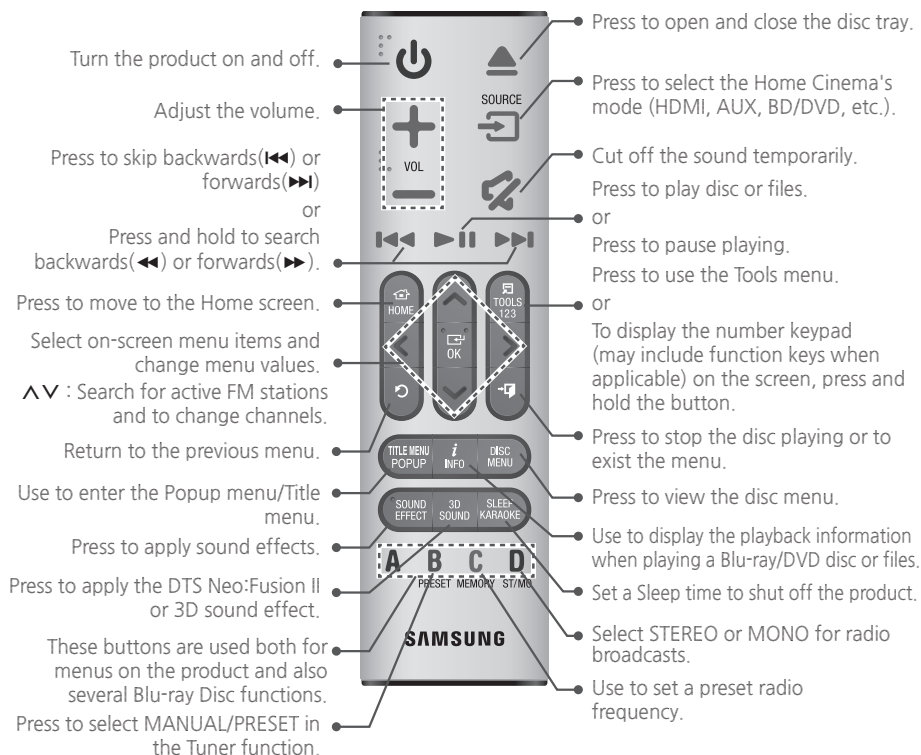

While playing multimedia content in **SAMSUNG APPS**, press and hold **▶||** button on the remote to pause playback. To stop playback, press and hold **➡** (EXIT) button on the remote.

### Installing batteries in the Remote Control



1 Use a coin to turn the remote control cover anti-clockwise to remove it as shown in the figure above.

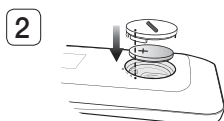

2 Insert a 3V lithium battery. Keep the positive (+) pole upward when inserting the battery. Put the battery cover on and align the '●' marks side by side as shown in the figure above.

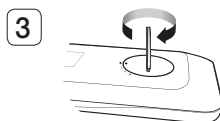

3 Use a coin to turn the cover clockwise as far as it will go to fix it in place.

# Connections

This section describes various methods of connecting the product to other external components. Before moving or installing the product, be sure to turn off the power and disconnect the power cord.

## Connecting the Speakers

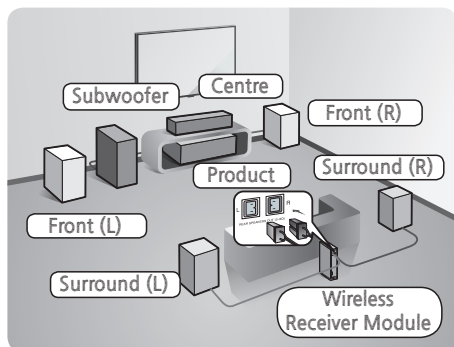

\* HT-H7500WM

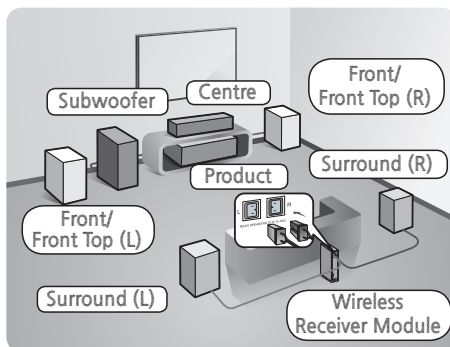

\* HT-H7750WM

### Position of the product

Place it on a stand or cabinet shelf, or under the TV stand.

### Selecting the Listening Position

The listening position should be located about 2.5 to 3 times the TV's screen size away from the TV. For example, if you have a 46 inch screen, locate the listening position 2.92 to 3.50 meters from the screen.

|  |  |
|--|--|
| <p>HT-H7500WM :<br/>Front Speakers</p>           | <p>Place these speakers in front of your listening position, facing inwards (about 45°) toward you. Place the front speakers so that their tweeters will be at the same height as your ear. Align the front face of the front speakers with the front face of the centre speaker or place them slightly in front of the centre speakers.</p>           |
| <p>HT-H7750WM :<br/>Front/Front Top Speakers</p> | <p>Place these speakers in front of your listening position, facing inwards (about 45°) toward you. Place the front speakers so that their tweeters will be at the same height as your ear. Align the front face of the front/front top speakers with the front face of the centre speaker or place them slightly in front of the centre speakers.</p> |
| <p>HT-H7500WM :<br/>Centre Speaker</p>           | <p>It is best to install the Centre Speaker at the same height as the front speakers. You can also install it directly over or under the TV.</p>   |
| <p>HT-H7750WM :<br/>Centre Speaker</p>           | <p>It is best to install the Centre Speaker at the same height as the front/front top speakers. You can also install it directly over or under the TV.</p>   |

# Connections

|                          |   |
|--------------------------|---|
| <b>Surround Speakers</b> | Place these speakers to the side of your listening position. If there isn't enough room, place these speakers so they face each other. Position them about 60 to 90cm above your ear, facing slightly downward.<br>* Unlike the front and centre speakers, the surround speakers are used mainly for sound effects. Sound will not come from them all the time. |
| <b>Subwoofer</b>         | The position of the subwoofer is not so critical. Place it anywhere you like.   |

- \* Surround speakers must be connected to the wireless receiver module.
- \* The appearance of your speakers may differ from the illustrations in this manual.
- \* Each speaker has a coloured label on its back or underside. Each cable has a single coloured band near its end. Match the band on each cable to the speaker label by colour, and then connect the cable to the speaker. See page 11 for exact instructions.

## Installing the Speakers on the Tallboy Stands

### \* HT-H7750WM only

1. Find the speaker cable that is attached to the Stand. Turn the Stand and Stand Base upside-down, unravel the speaker cable, and then draw it through the hole in the Stand Base.

 Handle the Stand carefully. It is heavy.

2. Connect the Stand Base to the bottom of the Stand.

3. Insert three 5x20 screws into the marked holes in the Stand Base, and then tighten them with a screwdriver as shown in the illustration.

4. Place the speaker cable into the slot on the bottom of the stand base.

5. Connect the assembled stand and a speaker together by matching the labels on the stand and speaker with each other as shown in the picture.

6. Insert a screw (5x20) into the hole on the rear of the speaker and tighten by turning it clockwise with a screwdriver.

7. Repeat steps 1 through 6 with the other speaker and stand.

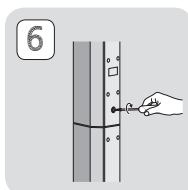
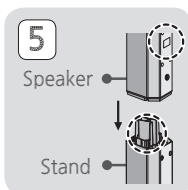
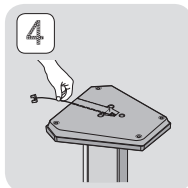
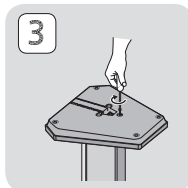
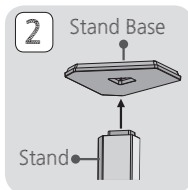
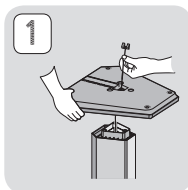

## Speaker Cable Connections

1. Match each speaker cable bundle to the correct speaker by matching the colour coded plug on each bundle to the coloured sticker on the bottom or back of each speaker.
2. Connect the speaker wire plugs from each speaker to the back of the product by matching the colours of the speaker plugs to the colours of the speaker jacks.

### HT-H7500WM

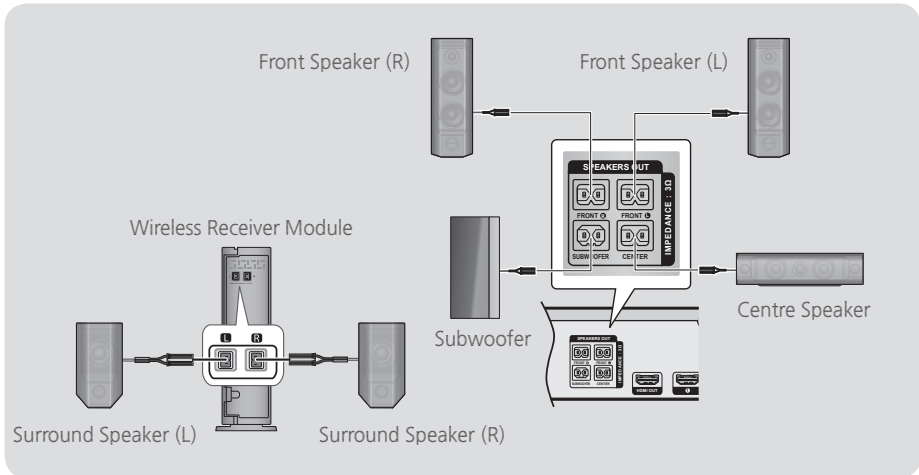

### HT-H7750WM

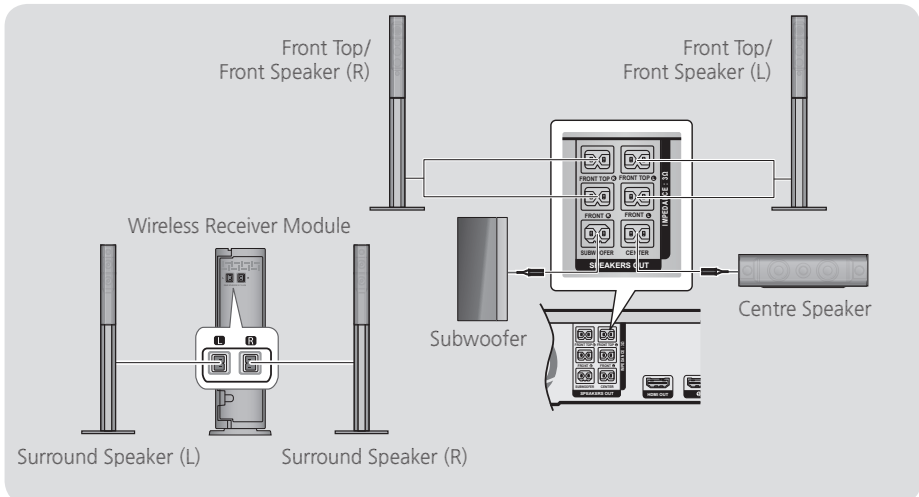

\* This product should be connected with the SWA-6000 only.

# Connections

- ✎ If you place a speaker near your TV set, the screen colour may be distorted because of the magnetic field.
- ✎ Place the wireless receiver module at the rear of the listening position. If the wireless receiver module is too close to the product, sound from the speakers may be disrupted because of interference.
- ✎ If you use a device such as a microwave oven, wireless LAN Card, Bluetooth device, or any other device that uses the 2.4/5.8GHz frequencies near the product, sound from the speakers may be disrupted because of interference.
- ✎ The maximum transmission distance from the product to the wireless receiver module is about 10m, but may vary depending on your operating environment. If a steel-concrete wall or metallic wall is between the product and the wireless receiver module, the system may not operate at all, because the radio waves cannot penetrate metal.
- ✎ If the product doesn't make a wireless connection, you need to run an ID Set between the product and wireless receiver module. With the product turned off, press and hold  (mute) button on the remote control for 5 seconds. Turn on the wireless receiver module. Then, press and hold the "ID SET" button on the back of the wireless receiver module for 5 seconds, and then turn the product on.

## | CAUTION |

- ▶ If you want to install the speakers on the wall, fasten screws or nails (not provided) firmly to the wall wherever you want to hang a speaker, and then, using the hole in the rear of each speaker, carefully hang each speaker on a screw or nail.
- ▶ Do not let children play with or near the speakers. They could get hurt if a speaker falls.
- ▶ When connecting the speaker wires to the speakers, make sure that the polarity (+/-) is correct.
- ▶ Keep the subwoofer speaker out of reach of children to prevent children from inserting their hands or alien substances into the duct (hole) of the subwoofer speaker.
- ▶ Do not hang the subwoofer on the wall using the duct (hole).
- ▶ The wireless receiving antenna is built into the wireless receiver module. Keep it away from water and moisture.
- ▶ For optimal listening performance, make sure that the area around the wireless receiver module location is clear of any obstructions.
- ▶ In 2-CH mode, you will hear no sound from the wireless surround speakers.

## Attaching the Toroidal Ferrite Core to the Power Cord of the Wireless Receiver Module (SWA-6000)

If you attach a Toroidal ferrite core to the power cord of the wireless receiver module, it will help prevent RF interference from radio signals.

1. Pull the fixing tab of the Toroidal ferrite core to open it.
2. Make two loops in the wireless receiver module power cord.
3. Attach the Toroidal ferrite core to the wireless receiver module's power cord as shown in the figure on the right, and then close it by pressing it until it clicks.
  - Attach the ferrite core as close to the Wireless Receiver Module as possible.

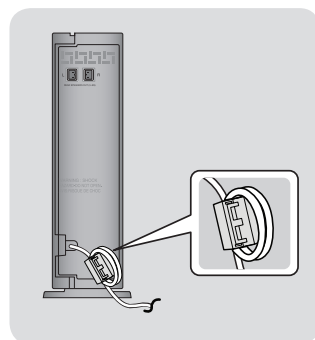

## Connecting to a TV and External Devices

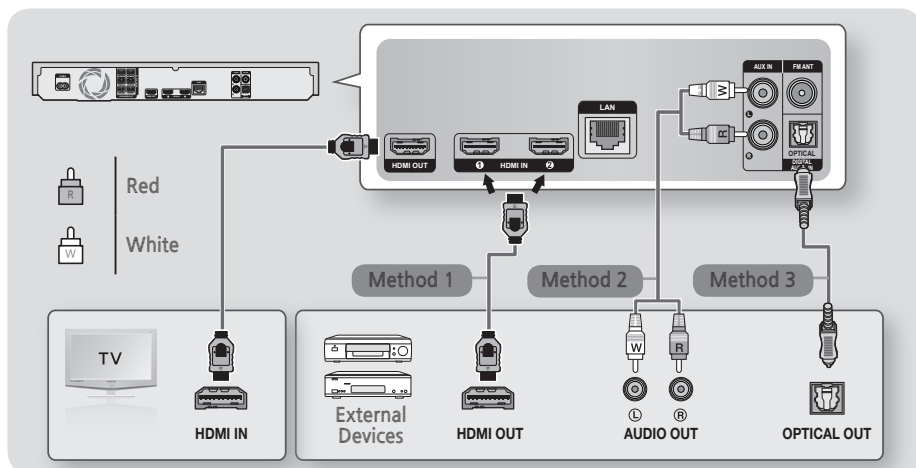

### Connecting to a TV

Connect an HDMI cable (not supplied) from the HDMI OUT jack on the back of the product to the HDMI IN jack on your TV. If the TV supports ARC, you can hear the audio from your TV through the home cinema with only this cable connected. See page 18 in this manual and the section on ARC in your TV's user's manual for details.

### Connecting to External Devices

#### Method 1 HDMI IN : Connecting to an External Component with an HDMI Cable

Connect an HDMI cable (not supplied) from the HDMI IN jack on the back of the product to the HDMI OUT jack on your digital device. → Select the **HDMI1** or **HDMI2** mode.

#### Method 2 AUX IN : Connecting an External Analogue Component

Using an RCA audio cable (not supplied), connect the AUDIO In jack on the product to the AUDIO Out jack on the external analogue component. → Select the **AUX** mode.

- Be sure to match the colours on the cable plugs to the colours on the input and output jacks.

#### Method 3 OPTICAL : Connecting an External Digital Audio Component

Use to connect the digital audio output of digital signal components such as Cable Boxes and Satellite Receivers (Set-Top-Boxes) to the home cinema. Using a digital optical cable (not supplied), connect the Optical Digital Audio In jack on the product to the Digital Optical Out jack of the external digital device using a digital optical cable. → Select the **D, IN** mode.

- 🔗 To see video from your Cable Box/Satellite receiver, you must connect its video output directly to your TV.
- 🔗 This system supports Digital sampling frequencies of 32 kHz or higher from external digital components.
- 🔗 This system supports only DTS and Dolby Digital audio. MPEG audio, a bitstream format, is not supported.

### Selecting an External Device to Use

To select an external device after you have connected it, press the **SOURCE** button. Each time you press the button, the mode changes in this order : **BD/DVD** → **D, IN** → **AUX** → **HDMI1** → **HDMI2** → **FM** → **BT**

# Connections

## Connecting to a Network Router

You can connect your product to your network router using one of the methods illustrated below.

### Wired Network

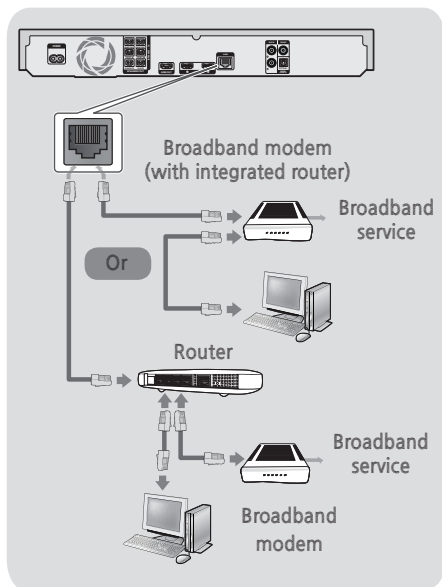

- ✎ Your router or your Internet Service Provider's policies may prevent the product from accessing Samsung's software update server. If this occurs, contact your Internet Service Provider (ISP) for more information.
- ✎ DSL users, please use a router to make a network connection.
- ✎ To use the DLNA function, you must connect your PC to your network as shown in the illustrations above. The connection can be wired or wireless.

### Wireless Network

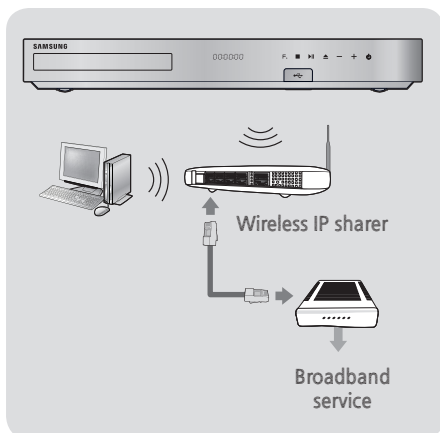

- ✎ If your wireless IP router supports DHCP, this product can use a DHCP or static IP address to connect to the wireless network.
- ✎ Set your wireless IP router to Infrastructure mode. Ad-hoc mode is not supported.
- ✎ The product supports only the following wireless security key protocols:
  - WEP (OPEN/SHARED), WPA-PSK (TKIP/AES), WPA2-PSK (TKIP/AES)
- ✎ Select a channel on the wireless IP router that is not currently being used. If the channel set for the wireless IP router is currently being used by another device nearby, it will result in interference and communication failure.
- ✎ In compliance with the newest Wi-Fi certification specifications, Samsung home cinemas do not support WEP, TKIP, or TKIP-AES (WPS2 Mixed) security encryption in networks running in the 802.11n mode.
- ✎ Wireless LAN, by its nature, may cause interference, depending on the operating conditions (AP performance, distance, obstacles, interference by other radio devices, etc).

## The Initial Settings Procedure

- The Home menu will not appear if you do not configure the initial settings.
- The OSD (On Screen Display) may change in this product after you upgrade the software version.
- The access steps may differ depending on the menu you selected.

After you have finished connecting the home cinema to your TV, turn on the TV, and then turn on the home cinema. The first initial setup screen appears. The setup screens appear in this order: Language, Network Configuration, Terms and Conditions, Screen Resolution (Aspect Ratio), and Speaker Layout. Depending on the software version installed on your home cinema, you may also see the Software Update screen. Follow the instructions displayed on each screen, which will guide you through the easy setup procedure.

If you are not ready to set up the network configuration or it is problematic, you can select **Skip** and set it up later. (See page 22)

 To edit your settings after the initial setup, select **Settings > System > Setup** in the Home screen or select the **Reset** option. (See page 21)

## The Home Screen at a Glance

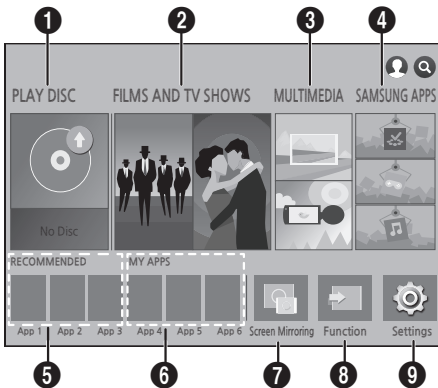

### 1 PLAY DISC

Displays information about the disc currently in the disc tray. Press OK to start playing the disc.

### 2 FILMS AND TV SHOWS

Download movies and TV Shows from the Internet.

 Depending on your country, this menu function may not be supported.

### 3 MULTIMEDIA

Play photos, videos, or music content from Discs, USB devices, PCs, mobile devices, or cloud services.

### 4 SAMSUNG APPS

Download/Access various for pay or free-of-charge applications.

### 5 RECOMMENDED

A list of useful and popular apps we recommend you download.

### 6 MY APPS

Displays downloaded and installed apps. You can change the display order. (See page 45)

### 7 Screen Mirroring

Set up the wireless mirroring function between the home cinema and a smart phone or tablet.

 Depending on your country, this menu function may not be supported.

### 8 Function

Use to switch between external devices connected to Digital In, Aux, HDMI 1, or HDMI 2, to switch to the Tuner, or to switch to a connected Bluetooth device. You can also use the remote's **SOURCE** button or the main unit's **F.** button.

### 9 Settings

Set various functions to suit your personal preferences.

# Settings

## ■ Selecting an Option on the Home Screen

- To select an option on the Home screen, move the cursor using the **▲▼<>** buttons until it highlights the option of your choice, and then press the OK button.

 If you leave the product in the stop mode for more than 5 minutes without using it, a screen saver will appear on your TV. If the product is left in the screen saver mode for more than 20 minutes, the power will automatically turn off.

|          |   |
|----------|---|
| <b>3</b> | <b>OK / DIRECTION Button :</b> <ul style="list-style-type: none"> <li>Press <b>▲▼&lt;&gt;</b> to move the cursor or select an item.</li> <li>Press the OK button to activate the currently selected item or confirm a setting.</li> </ul> |
| <b>4</b> | <b>➔ (EXIT) Button :</b> Press to exit the current menu.  |

## Accessing the Settings Screen

- Select **Settings** on the Home screen, and then press OK. The **Settings** screen appears.

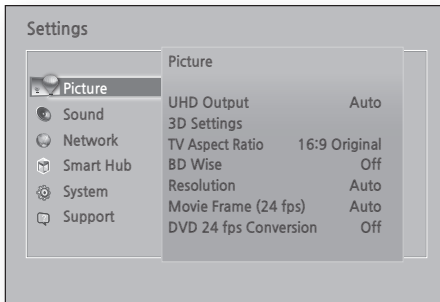

- To access the menus, sub-menus, and options on the Settings screen, please refer to the remote control illustration below.

## Buttons on the Remote Control Used for the Settings Menu

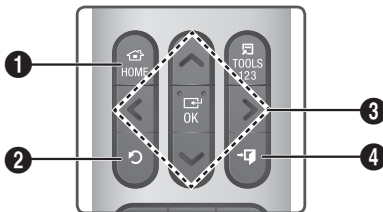

|          |  |
|----------|--|
| <b>1</b> | <b>HOME Button :</b> Press to move to the Home screen.           |
| <b>2</b> | <b>➔ (RETURN) Button :</b> Press to return to the previous menu. |

## Detailed Function Information

Each **Settings** function, menu item, and individual option is explained in detail on-screen. To view an explanation, use the **▲▼<>** buttons to select the function, menu item, or option. The explanation will usually appear on the right of the screen.

A short description of each **Settings** function starts below. Additional information on some of the functions is also in the Appendix of this manual.

## Settings Menu Functions

### Picture

#### UHD Output

This option outputs HDMI video at UHD (Ultra High Definition) resolution. This is only available when Movie Frame is set to **Auto**.

 To use this feature, you must connect the product to a device that supports UHD resolution and you must have content that plays at 24Fs (film speed).

### 3D Settings

Set up the 3D related functions.

✓ **3D Blu-ray Playback Mode:** Select whether to play a Blu-ray Disc with 3D contents in 3D Mode. If you move to the Home or Smart Hub Home menu while in 3D mode, the product will switch to 2D automatically.

✓ **Screen Size:** Enter the size of the TV attached to the product. The product will automatically adjust the 3D output to the screen size of the TV.

 Carefully read the health and safety information before viewing 3D content. (See page 3)

### TV Aspect Ratio

Lets you adjust the output of the product to the screen size of your TV. (See page 51)

### BD Wise

**BD Wise** is Samsung's latest inter-connectivity feature.

When you connect a Samsung product and a Samsung TV with **BD Wise** to each other via HDMI, and **BD Wise** is on in both the product and TV, the product outputs video at the video resolution and frame rate of the Blu-ray/DVD Disc.

### Resolution

Lets you set the output resolution of the HDMI video signal to **BD Wise, Auto, 1080p, 1080i, 720p, 576p/480p**. The number indicates the number of lines of video per frame. The i and p indicate interlaced and progressive scan, respectively.

The more lines, the higher quality.

### Movie Frame (24 fps)

Setting the **Movie Frame (24 fps)** feature to **Auto** lets the product adjust its HDMI output to 24 frames per second automatically for improved picture quality if attached to a 24Fs compatible TV.

- You can enjoy the **Movie Frame (24 fps)** feature only on a TV supporting this frame rate.
- Movie Frame is only available when the product is in the HDMI 1080p output resolution modes.

### DVD 24 fps Conversion

Converts DVD playback to 24 frames per second and outputs it via HDMI. This option is only available when **Movie Frame (24 fps)** is set to on.

### Fit Screen Size

Lets you select the optimal size for the Smart Hub or **Screen Mirroring** Screen.

### HDMI Colour Format

Lets you set the colour space format for the HDMI output to match the capabilities of the connected device (TV, monitor, etc).

### HDMI Deep Colour

Lets you set the product to output video from the HDMI OUT jack with Deep Colour. Deep Colour provides more accurate colour reproduction with greater colour depth.

### Progressive Mode

Lets you improve picture quality when viewing DVDs.

## Sound

### Simple Speaker Setup (HT-H7500WM only)

Lets you configure the settings of the speakers you have connected to obtain the best possible surround sound.

- ✓ **Normal Mode** : Select if you have set up your speakers in the recommended speaker layout with the surround speakers next to or behind the listening positions.
- ✓ **Simple Mode** : Select if you have put your surround speakers in front of the listening position. Downmixes the front sound to the surround sound speakers.

✎ SFE, Virtual 7.1 will not operate when the **Simple Mode** is on.

### Speaker Settings

- ✓ **Sound Output** : Lets you select which speakers are active, either the TV's speakers or the home cinema's speakers.
- ✓ **Settings (Home theatre speakers)** : Lets you adjust the following speaker settings and turn the test tone on and off so you can test the speakers.
  - **Volume Level** : Lets you adjust the relative loudness of each speaker from 6dB to -6dB. For example, if you like deep bass, you can increase the loudness of the subwoofer by 6dB.
  - **Distance** : Lets you adjust the relative distance of each speaker from the listening position up to 10 meters. The farther the distance, the louder the speaker will be.
  - **Speaker Test** : Begins a test to set the best surround sound configuration. Press **Stop Test** to stop the test while it is in progress.

# Settings

- ✓ **Settings (Multiroom Link)** : You can enjoy sound through a remote speaker that is connected to the home cinema through your home network. To use the network speaker, select **Multiroom**. If there is a network speaker available, it will appear on the screen.
  - **Don't Use** : The network speaker is not used.
  - **Multiroom** : The network speaker outputs audio. All network speakers output the same audio regardless of channel using the PCM format only.
- 🔗 **SOUND EFFECT and 3D SOUND** are not applied if **Multiroom** is set to on.
- 🔗 The network speaker is not available when **Screen Mirroring** is active.
- 🔗 For further details, refer to the Multiroom Link manual from the web site.  
[www.samsung.com](http://www.samsung.com) > Support > Search for the product name > Multiroom Link > Download PDF

## Sound Customiser

Sound Customiser lets you calibrate the home cinema for the optimal sound quality based on your hearing level and the ambient conditions.

To create a Custom Sound Profile, follow these steps:

1. In the **Sound Customiser** Menu, select **Add Custom Sound**.
2. On the next screen, select **Start**. The **Preview** screen appears.
3. Select **Preview** to preview the Test Sound. Select **Next**, and then press OK to continue.
4. A 6-step test will start. During each stage, the TV will sound a test tone at a different frequency. The tone will begin softly and increase in volume. Select **Yes** when you can hear the test tone. If you want to listen to it again, select **Retry**. Each time you select **Yes**, the TV will move on to the next tone. Once the test is complete, a screen appears that lets you compare the original sound to the calibrated sound.
5. Select **Next**, and then press the OK button to continue. The on-screen keyboard appears with a default profile name.
6. Enter a name for the calibrated sound profile or accept the default name, select **Done**, and then press the OK button.

7. Select **Done** on the next screen, and then press the OK button. The **Sound Customiser** screen reappears.
- ✓ **Custom Sound Profile** : Select a Sound Profile you created to activate it. Or select Hearing Impaired, a Custom Sound Profile especially composed of large sounds for those with hearing disorders.
  - 🔗 If there are more than 3 Custom Sounds registered, Family mode will be activated which is composed of the average value of all registered profiles.
  - ✓ **Add Custom Sound** : Create and add a new Custom Sound Profile. See the instructions above.
  - ✓ **Edit Custom Sound** : Choose a Custom Sound Profile to modify it. Follow the same steps you used when creating a sound profile. This function is only available if you have added a Custom Sound Profile using Add Custom Sound. (See above.)
  - ✓ **Manage Custom Sound** : Rename or delete Custom Sound Profiles. This function is only available if you have added a Custom Sound Profile using Add Custom Sound. To select a profile, highlight the check box to the right of the profile, and then select Rename or Delete.

## Equaliser

Lets you configure the **Equaliser** settings manually.

## Smart Volume

Lets you set the product so that the volume remains stable when a scene change occurs or when you change the channel.

## Audio Return Channel

Lets you direct the sound from the TV to the Home Cinema speakers. Requires an HDMI connection and an **Audio Return Channel** (ARC) compatible TV.

- If **Audio Return Channel** is set to **On** and you are using an HDMI cable to connect the product to the TV, digital optical input is disabled.
- If **Audio Return Channel** is set to **Auto** and you are using an HDMI cable to connect the product to the TV, ARC or digital optical input is selected automatically.

### Digital Output

Lets you set the **Digital Output** to match the capabilities of the AV receiver you've connected to the product. For more details, please refer to the digital output selection table. (See page 57)

### Dynamic Range Control

Lets you apply dynamic range control to Dolby Digital, Dolby Digital Plus, and Dolby TrueHD audio.

- ✓ **Auto**: Automatically controls the dynamic range of Dolby TrueHD audio, based on information in the Dolby TrueHD soundtrack. Also turns dynamic range control off for Dolby Digital and Dolby Digital Plus.
- ✓ **Off**: Leaves the dynamic range uncompressed, letting you hear the original sound.
- ✓ **On**: Turns dynamic range control on for all three Dolby formats. Quieter sounds are made louder and the volume of loud sounds is reduced.

### Downmixing Mode

Lets you select the multi-channel downmix method that is compatible with your stereo system. You can choose to have the product downmix to **Normal Stereo** or to **Surround Compatible**.

### Audio Sync

When the product is attached to a digital TV, lets you adjust the audio delay so that the audio syncs with the video. You can set the delay between 0 and 300 milliseconds.

- ✎ The **Auto** function in **Audio Sync** is guaranteed to work only with a Samsung TV that supports the ARC function (the Anynet+ function).

## Network

### Network Status

Lets you check the current network and Internet status.

### Network Settings

Lets you configure the network connection so you can enjoy various features such as Internet services or AllShare Wi-Fi functionality, and perform software upgrades.

### Wi-Fi Direct

Lets you connect a **Wi-Fi Direct** device to the product using a peer-to-peer network, without the need for a wireless router. Note that if the product is connected to a wireless network, it may be disconnected when you use **Wi-Fi Direct**. (See page 24)

- ✎ Text files, such as files with a .TXT or .DOC extension, will not display when you are using the **Wi-Fi Direct** function.

### Multimedia Device Settings

Allow other devices on your network, such as smart phones and tablets, to share content with your product.

### Device Name

Lets you assign an identifying name to the product. You use this name to identify the product when you are connecting external Wi-Fi devices (smart phones, tablets, etc.) to it.

### BD-Live Settings

Lets you set various BD-Live functions. BD-Live allows you to access extra features available on some Blu-ray Discs if you are connected to the Internet.

- ✓ **BD-Live Internet Connection** : Lets you fully allow, partly allow, or prohibit a BD-Live Internet connection.
- ✓ **BD Data Management** : Manage BD data downloaded from a BD-Live service or Blu-ray Disc.

- ✎ To use BD-Live, you must insert a USB storage device into the home cinema's USB port.

# Settings

## Smart Hub

### VOD Rating Lock

Lets you lock access to Video on Demand (VOD) content based on its rating. To use, you must enter the security PIN. Press and hold the **123** button until the Num pad appears on the screen. When the Num pad appears, select a number using the **▲▼<>** button and then press the **OK** button.

- 🔑 The default security PIN is 0000.
- 🔑 Depending on your country, this menu function may not be supported.

### Caption

Use to modify captions on VOD playback that supports closed captions. Lets you change displayed caption's font colour and size.

- 🔑 The **Caption** function does not work with VOD services that don't support closed captions. For some VOD services that do support closed captions, the functions settings may not be applied.
- 🔑 Depending on your country, this menu function may not be supported.

### Terms & Policy

#### Samsung account Terms and Conditions, Privacy Policy

You can view the terms of use and privacy policy for Smart Hub, Samsung accounts, and various other services.

### Reset Smart Hub

Resets all Smart Hub settings to their default settings. To use, you must enter the security PIN. Press and hold the **123** button until the Num pad appears on the screen. When the Num pad appears, select a number using the **▲▼<>** button and then press the **OK** button.

- 🔑 The default security PIN is 0000.

## System

### Setup

Lets you re-run the Initial Settings procedure. Refer to the descriptions displayed on the screen.

### Quick start

Lets you set the product to turn on quickly by decreasing the boot time.

- 🔑 If this function is set to **On**, Standby power consumption will increase. (About 12W ~ 20W)

### Language

Lets you select the language you prefer for the on-screen menu, disc menu, audio, subtitles, etc.

- The language you select for the disc menu, disc audio, or subtitles will only appear if it is supported on the disc.

### Device Manager

Lets you connect a wireless USB keyboard or mouse to the USB port on the front of the product.

- ✓ **Keyboard Settings:** Lets you configure a wireless USB keyboard connected to the product.
  - 🔑 You can use the keyboard only when a **QWERTY** keyboard screen or window appears in the Web Browser.
- ✓ **Mouse Settings:** Lets you configure a wireless USB mouse connected to the product. You can use the mouse in the product's menu in the same way you use a mouse on your PC.
  - To use a mouse with the product's menu:
    1. Connect the USB mouse to the product.
    2. Click the primary button you selected in **Mouse Settings**. The Simple Menu appears.
    3. Click the menu options you want.
  - 🔑 Some USB HID keyboards and mice may not be compatible with your product.
  - 🔑 Some HID keyboard keys may not work.
  - 🔑 Wired USB keyboards are not supported.
  - 🔑 Some applications may not be supported.
  - 🔑 If a wireless HID Keyboard does not operate because of interference, move the keyboard closer to the product.

## Security

Press and hold the **123** button until the Num pad appears on the screen. When the Num pad appears, select a number using the **^V<>** button and then press the **OK** button. The default security PIN is 0000. Enter the default PIN to access the security function if you haven't created your own PIN.

- ✓ **BD Parental Rating:** Prevents playback of Blu-ray Discs with a rating equal to or above a specific age rating you have set unless you enter the PIN.
- ✓ **DVD Parental Rating:** Prevents playback of DVDs with a rating above a specific numerical rating you have set unless you enter the PIN.
- ✓ **Change PIN:** Lets you change the 4-digit PIN used to access security functions.
  - If you forget your PIN
    1. Remove any disc or USB storage device.
    2. Press and hold the **■** button on the front panel for 5 seconds or more. All settings will revert to the factory default settings.

 When the factory default settings are restored, all the user stored BD data is deleted.

## General

Lets you specify the display brightness and time zone.

- ✓ **Front Display:** Lets you change the brightness of the front panel.
- ✓ **Time Zone:** You can specify the time zone that is applicable to your area.
- ✓ **Menu Transparency:** Lets you adjust the transparency of the menu box.

## Anynet+ (HDMI-CEC)

Anynet+ is a convenient function that offers linked operations with other Samsung products that have the Anynet+ feature, and lets you control those products with one Samsung TV remote. To operate this function, you must connect this product to an Anynet+ Samsung TV using an HDMI cable.

To use an **Anynet+ (HDMI-CEC)** function, follow the instructions below.

- 1) Connect the product to an **Anynet+ (HDMI-CEC)**-compliant Samsung TV using HDMI Cable.

- 2) Set the **Anynet+ (HDMI-CEC)** feature to **On** in both the TV and the product.
- 3) Search for and then select the product in the TV's **Anynet+ (HDMI-CEC)** list. For more exact instructions, see the Anynet+ section of the TV's user's manual.

## DivX® Video On Demand

View DivX® VOD Registration Codes to purchase and play DivX® VOD contents.

## Support

### Remote Management

When activated, lets Samsung Call Centre agents diagnose and fix problems with the product remotely. Requires an active Internet connection. **Remote Management** service might not be available in some countries.

### Software Update

For more information about the **Software Update** function, see "Upgrading Software" on page 25.

### Usage Mode

Lets you set the **Usage Mode**. If you are using the home cinema at home, always select **Home Use**. **Store Demo** is for retail display settings only.

### Contact Samsung

Provides contact information for assistance with your product.

### Reset

Reverts all settings to their defaults except for the network and Smart Hub settings. Requires that you enter your security PIN. Press and hold the **123** button until the Num pad appears on the screen. When the Num pad appears, select a number using the **^V<>** button and then press the **OK** button. The default security PIN is 0000.

# Settings

## Network Setup

When you connect this product to a network, you can use network based applications and functions such as Smart Hub and BD-LIVE, and upgrade the product's software through the network connection. For more information about accessing and using Internet services, see the Network Services chapter of this manual on pages 43~50. Instructions for configuring the network connection start below.

### Configuring Your Network Connection

If you didn't configure your network connection during the initial settings procedure or you need to reset the network connection, follow the directions below.

Before you begin, contact your Internet Service Provider to find out if your IP address is static or dynamic. If it is dynamic, and you have a wired or wireless network, we recommend using the Automatic configuration procedures described below.

If you are connecting to a wired network, connect the product to your router using a LAN cable before you start the configuration procedure.

To begin configuring your network connection, follow these steps:

1. In the Home screen, select **Settings**, and then press the OK button.
2. Select **Network**, and then press the OK button.
3. Select **Network Settings**, and then press the OK button.
4. Go to the instructions for Wired networks starting or the instructions for Wireless networks starting on the next page.

### Wired Network

#### □ Wired - Automatic

After following Steps 1 to 3 above:

1. In the **Network Settings** screen, change **Network type to Wired**. Then, select **Connect** and press the OK button. The product detects the wired connection, verifies the network connection, and then connects to the network.
2. When it is done, highlight **OK**, and then press OK button.

#### □ Wired - Manual

If you have a static IP address or the automatic procedure does not work, you'll need to set the **Network Settings** values manually.

After following Steps 1 to 3 above:

1. In the **Network Settings** screen, change **Network type to Wired**. Then, select **Connect** and press the OK button. The product searches for a network, and then displays the connection failed message.

✎ If it is possible to connect the home cinema to your network wirelessly, select **Change Network** at this point, change the **Network type to Wireless**, and then go to the instructions for wireless networks on the next page.

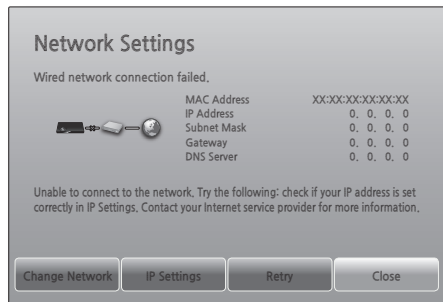

2. Use the <> buttons to select **IP Settings**, and then press the OK button. The **IP Settings** screen appears.
3. Select the **IP setting** field, and then set it to **Enter manually**.
4. Select a parameter to enter (**IP Address**, for example), and then press OK. Use the **^V** buttons on the remote control to enter the numbers for the parameter. Or use the Num keypad to enter a parameter number. Press and hold the **123** button until the Num pad appears on the screen. When the Num pad appears, select a number using the **^V<>** button and then press the OK button. Use the **<>** buttons on the remote control to move from entry field to entry field within a parameter. When done with one parameter, press the OK button.
5. Press the **^** or **V** button to move to another parameter, and then enter the numbers for that parameter following the instructions in Step 4.
6. Repeat Steps 4 and 5 until you have filled in all parameters.

- 🔑 You can get the network parameter values from your Internet provider.
7. When finished entering all the parameter values, select **OK**, and then press the **OK** button. The home cinema verifies the network connection and then connects to the network.

## Wireless Network

You can set up a wireless network connection in three ways:

- Wireless Automatic
- Wireless Manual
- WPS(PBC)

Before you configure the wireless network connection, disconnect any wireless network devices currently connected to the product or, if applicable, the product's current wired connection.

### ❑ Wireless - Automatic

After following Steps 1 to 3 in "Configuring Your Network Connection" on page 22:

1. In the **Network Settings** screen, change **Network type** to **Wireless**. The product searches for and then displays a list of the available networks.

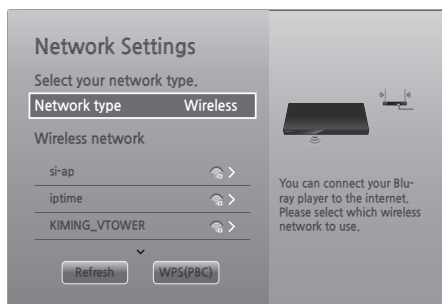

2. Select the desired network, and then press the **OK** button.
3. On the Security screen, enter your network's security code or pass phrase. Enter letters by selecting a letter with **^V<>** buttons, and then pressing **OK** button.
4. When finished, select **Done**, and then press the **OK** button. The product verifies the network connection and then connects to the network.

- 🔑 You should be able to find the security code or pass phrase on one of the set up screens you used to set up your router or modem.

### ❑ Wireless - Manual



If you have a static IP address or the Automatic procedure does not work, you'll need to set the Network Settings values manually.

After following Steps 1 to 3 in "Configuring Your Network Connection" on page 22:

1. In the **Network Settings** screen, change **Network type** to **Wireless**. The product searches for and then displays a list of the available networks.
2. Scroll through the list, select the desired network or **Add Network**, and then press the **OK** button.
3. If you selected a network in Step 2, go to Step 6. If you selected **Add Network**, go to Step 4.
4. Enter your wireless network or wireless router's name.
  - Enter letters by selecting a letter with the **^V<>** buttons, and then pressing the **OK** button.
  - To display capital letters (or redisplay lower case letters if capital letters are displayed), select **^**, and then press the **OK** button.
  - To display symbols and punctuation, select **123#&**, and then press the **OK** button. To redisplay letters, select **123#&**, and then press the **OK** button.
 When finished, select **Done**, and then press the **OK** button.

5. On the **Security type** screen that appears, use the **^V** buttons to select the network's **Security type**, and then press the **OK** button. On the next screen, enter your network's security code or pass phrase.
  - Enter letters by selecting a letter with the **^V<>** buttons, and then pressing the **OK** button.
 When finished, select **Done**, and then press the **OK** button. The product searches for the network.
6. The Network connection fail screen appears. Use **<>** buttons to select **IP Settings**, and then press the **OK** button.

# Settings

7. Select the **IP setting** field, and then set it to **Enter manually**.
8. Select a network parameter to enter (**IP Address**, for example), and then press **OK** button. Use the **▲▼** buttons on the remote control to enter the numbers for the parameter. Or use the Num keypad to enter a parameter number. Press and hold the **123** button until the Num pad appears on the screen. When the Num pad appears, select a number using the **▲▼<>** button and then press the **OK** button. Use the **<>** buttons on the remote control to move from entry field to entry field within a parameter. When done with one value, press the **OK** button.
9. Press the **▲** or **▼** button to move to another parameter, and then enter the numbers for that parameter following the instructions in Step 8.
10. Repeat Steps 8 and 9 until you have filled in all parameters.  
 You can get the Network parameter values from your Internet provider.
11. When finished, select **OK**, and then press the **OK** button. The Security screen appears.
12. On the Security screen, enter your network's security code or pass phrase. Enter letters by selecting a letter with the **▲▼<>** buttons, and then pressing the **OK** button.
13. When finished, select **Done** at the right of the screen, and then press the **OK** button. The product verifies the network connection and then connects to the network.
14. After the home cinema verifies the network, select **OK**, and then press the **OK** button.  
 You can also begin the Manual Network setup by going to **Settings > Network > Network Status**.

## □ WPS(PBC)

One of the easiest ways to set up the wireless network connection is using the **WPS(PBC)** function. If your wireless router has a **WPS(PBC)** button, follow these steps:

After following Steps 1 to 3 in "Configuring Your Network Connection" on page 22:

1. In the **Network Settings** screen, change **Network type** to **Wireless**. The product searches for and then displays a list of the available networks.
2. Scroll the list down, select **WPS(PBC)**, and then press the **OK** button.

3. Press the **WPS(PBC)** button on your router within two minutes. Your product automatically acquires all the network settings values it needs and connects to your network after the network connection is verified.

4. When it is done, highlight **OK**, and then press the **OK** button.

 For a WPS connection, set your wireless router's security encryption to AES. WEP security encryption does not support a WPS connection.

## Wi-Fi Direct

The **Wi-Fi Direct** function allows you to connect **Wi-Fi Direct** devices to the product and each other using a peer-to-peer network, without a wireless router.

 Some **Wi-Fi Direct** devices may not support the AllShare function if connected via **Wi-Fi Direct**. If this is the case, change the network connection method you used to connect the device to the home cinema.

 **Wi-Fi Direct** transmissions can interfere with Bluetooth signals. Before you use the Bluetooth function, we strongly recommend that you turn off the **Wi-Fi Direct** function on any device in which it is currently on.

1. Turn on the **Wi-Fi Direct** device and activate its **Wi-Fi Direct** function.
2. In the Home screen, select **Settings**, and then press the **OK** button.
3. Select **Network**, and then press the **OK** button.
4. Select **Wi-Fi Direct**, and then press the **OK** button.  
The **Wi-Fi Direct** devices that you can connect the home cinema to appear.



5. You have three ways to complete the Wi-Fi connection:

- Through the Wi-Fi device.
- Through the product using PBC.
- Through the product using a PIN.

Each is covered below.

### Through the Wi-Fi Device

1. On the Wi-Fi device, follow the device's procedure for connecting to another **Wi-Fi Direct** device. See the device's user manual for instructions.
2. When you have completed the procedure, you should see a pop-up on your TV screen saying that a device that supports **Wi-Fi Direct** has requested to connect. Select **OK**, and then press the **OK** button to accept.
3. The Connecting pop-up appears, followed by the Connected pop-up. When it closes, you should see the device listed on the **Wi-Fi Direct** screen as connected.

- The PBC and PIN procedures connect devices automatically.

### Through the Product Using PBC

1. Select the **Wi-Fi Direct** device you want to connect to this product, and then press the **OK** button.
2. The Connecting pop-up appears, followed by the Connected pop-up. When it closes, you should see the device listed on the **Wi-Fi Direct** screen as connected.

### Through the Product Using a PIN

1. Select the **Wi-Fi Direct** device you want to connect to this product, and then press the **OK** button.
2. The PIN pop-up appears.
3. Note the PIN code in the pop-up, and then enter it into the appropriate field in the **Wi-Fi Direct** device you want to connect.
4. The Connecting pop-up appears, followed by the Connected pop-up. When it closes, you should see the device listed on the **Wi-Fi Direct** screen as connected.

- ✎ The current wired or wireless network connection will be disconnected when you use the **Wi-Fi Direct** function.
- ✎ Text files, such as files with a .TXT or .DOC extension, will not display when you are using the **Wi-Fi Direct** function.

## Upgrading Software

The **Software Update** menu allows you to upgrade the product's software for performance improvements or additional services.

- Never turn the product off or back on manually during the update process.

1. In the Home menu, select **Settings**, and then press the **OK** button.
  2. Select **Support**, and then press the **OK** button.
  3. Select **Software Update**, and then press the **OK** button.
  4. To download update software and update now, select **Update now**, and then press the **OK** button. See "Update now" on the next page for details.
  5. To let the product download update software automatically when available, select **Auto update**, and then press the **OK** button. (See page 26)
- ✎ The upgrade is complete when the product turns off, and then turns on again by itself.
  - ✎ Samsung Electronics takes no legal responsibility for product malfunction caused by an unstable Internet connection or consumer negligence during a software upgrade.
  - ✎ If you want to cancel the upgrade while the upgrade software is downloading, press the **OK** button.
  - ✎ When a system upgrade is in progress, "UPDATE" is displayed on the front panel.

# Settings

## Update now

---

You can use **Update now** to update the software through your network connection or by using a USB flash drive. The network instructions are below. The USB flash drive instructions are on this page.

1. Select **Update now**, and then press the **OK** button. The Update now pop-up appears.
2. The product searches on line for the latest software version.
3. If it does not find an update, the "There are no new updates for you at the moment." pop-up appears. Press the **OK** button to exit.
4. If it finds a new version, the Update Request pop-up appears.
5. Select **OK**. The product upgrades the software, turns off, and then turns on automatically.
6. If you do not select **OK** or **Cancel** in one minute, the product stores the new upgrade software. You can upgrade the software later using **Auto update**.
7. If you select **Cancel**, the product cancels the upgrade.

 When the system upgrade is done, check the software details in the Product Information section of the Contact Samsung screen.

 Do not turn off the product during the Software Upgrade. It may cause the product to malfunction.

## Auto update

---

You can set the **Auto update** function so that the product downloads new upgrade software when it is in **Auto update** mode.

In **Auto update** mode, the product is on, but its Internet connection is active. This allows the product to download upgrade software automatically, when you are not using it.

1. Press the **▲▼** buttons to select **Auto update** mode, and then press the **OK** button.
2. Select **On** or **Off**.  
If you select **On**, the product will automatically download new upgrade software when it is in Auto update mode with the power on. If it downloads new upgrade software, the product will ask you if you want to install it when you turn the product on.

 To use the **Auto update** function, your product must be connected to the Internet.

## Update by USB

---

1. Visit [www.samsung.com](http://www.samsung.com).
2. Click **SUPPORT** on the top right of the page.
3. Enter the product's model number into the search field. As you enter the model number, a drop down will display products that match the model number.
4. Left click your product's model number in the drop down list.
5. On the page that appears, scroll down to and then click **Firmware Manuals & Downloads**.
6. Click **Firmware** in the centre of the page.
7. Click the **ZIP** button in the File column on the right side of the page.
8. Click **Send** in the first pop-up that appears. Click **OK** in the second pop-up to download and save the firmware file to your PC.
9. Unzip the zip archive to your computer. You should have a single folder with the same name as the zip file.
10. Copy the folder to a USB flash drive.
11. Make sure no disc is inserted in the product, and then insert the USB flash drive into the USB port of the product.
12. In the product's menu, go to **Settings > Support > Software Update**.
13. Select **Update now**.
14. The product searches for the software on the USB drive. When it finds the software, the Update Request pop-up appears.
15. Select **OK**. The product upgrades the software, turns off, and then turns on automatically.
16. There should be no disc in the product when you upgrade the software using the USB jack.  
 When the system upgrade is done, check the software details in the Product Information section of the Contact Samsung screen.  
 Do not turn off the product during the software upgrade. It may cause the product to malfunction.  
 Software upgrades using the USB jack must be performed with a USB flash drive only.

# Playing Content

Your home cinema can play content located on Blu-ray/DVD/CD discs, USB devices, PCs, smart phones, tablets, and on the Web.

To play content located on your PC or a mobile device, you must connect the PC or mobile device and the product to your network. To play content on your PC, you must also download and install AllShare network software or already have DLNA network software on your PC.

 PCs running Windows 7 and Windows 8 have DLNA software (Play To) built in.

## Playing Commercial Discs

1. Press the **▲** button to open the disc tray.
2. Place a disc gently into the disc tray with the disc's label facing up.

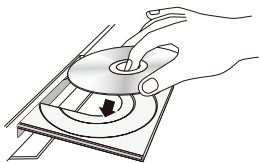

3. Press the **▲** button to close the disc tray. Playback starts automatically.
4. If playback does not start automatically, press the **▶||** button on the remote.

## Disc Storage & Management

### • Holding Discs

- Fingerprints or scratches on a disc may reduce sound and picture quality or cause skipping.
- Avoid touching the surface of a disc where data has been recorded.
- Hold the disc by the edges so that fingerprints will not get on the surface.
- Do not stick paper or tape on the disc.





### • Cleaning Discs

- If you get fingerprints or dirt on a disc, clean it with a mild detergent diluted in water and wipe with a soft cloth.



- When cleaning, wipe gently from the inside to the outside of the disc.
- Disc Storage
  - Do not keep in direct sunlight.
  - Keep in a cool ventilated area.
  - Keep in a clean protective jacket and store vertically.

## Playing Multimedia Files

1. In the Home screen, select **MULTIMEDIA**, and then press the **OK** button. The Recently Played screen appears.
  2. Select **Storage**, **Network Device**, or **Storage Service** at the bottom of the screen.
    - **Storage** - Displays storage devices connected to the product.
    - **Network Device** - Displays mobile devices, PCs, tablets, and similar devices connected through the network.
    - **Storage Service** - Displays the cloud services you are logged in to.
-  When you select an item, information about the item scrolls across the bottom of the item's listing window.
3. Select an item or device, and then press the **OK** button. A screen appears listing the contents of the item or device. Depending on how the contents are arranged, you will see either folders, individual files, or both.
  4. If necessary, use the **▲▼<>** buttons to select a folder, and then press the **OK** button.
  5. Use the **▲▼<>** buttons to select a file to view or play, and then press the **OK** button.
  6. The selected file plays.
  7. Press the **○** (**RETURN**) button to exit a folder or the **➔** (**EXIT**) button to return to the Home screen.
  8. Go to pages 29~41 for instructions that explain how to control playback of videos, music, and pictures on a storage device.
-  To list only one type of media file, use the **Filter** (**▼**) function in the top-right corner of the item or device screen.

# Playing Content

- In the **Filter**(▼) drop down, select **Photos**, **Videos**, or **Music**.
- Even though the product will display folders that contain all content types, it will only display files of the content type you selected. For example, if you selected **Music**, you will only be able to see music files.

## Playing Files on a Storage Device

### Method 1 : If the product is turned on after you connect a storage device

- Turn the product on.
- Follow the directions in "Playing Multimedia Files" on page 27. In Step 2, select **Storage**.

### Method 2 : If you connect a USB device while the product is turned on

- Connect the storage device to the product. (a recorded CD, a USB device, etc.) The "**New device connected.**" pop-up appears. If two or more storage devices are connected, use the <> buttons to switch between devices.

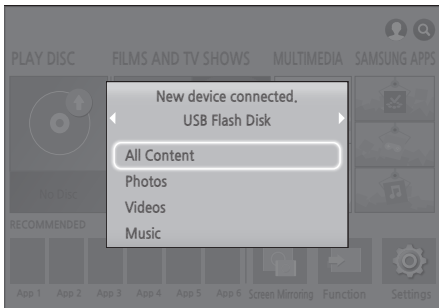

- If the pop-up does not appear, go to Method 1.
- Use the ▲▼ buttons to select **All Content**, **Photos**, **Videos**, or **Music**, and then press the OK button. Depending on how the contents are arranged, you will see either folders, individual files, or both.
- To list only one type of media file, use the **Filter**(▼) function in the top-right corner of the item or device screen.

- In the **Filter**(▼) drop down, select **Photos**, **Videos**, or **Music**.
  - Even though the product will display folders that contain all content types, it will only display files of the content type you selected. For example, if you selected **Music**, you will only be able to see music files.
  - If necessary, use the ▲▼<> buttons to select a folder, and then press the OK button.
  - Select a file to view or play, and then press the OK button.
  - Press the ⏪ (RETURN) button to exit a folder or the ⏩ (EXIT) button to return to the Home screen.
  - Go to pages 29~41 for instructions that explain how to control playback of videos, music, and pictures on a storage device.
- If you insert a disc when playing a USB device or phone, the device mode changes to "Disc" automatically.
  - If your cellular phone is DLNA compatible, you can play contents without connecting a USB cable.

## Playing Media Content Saved on a Computer/Mobile Device

You can play media content on the Home cinema that is stored on a computer or mobile device connected to the same network as the Home cinema.

- Samsung Link software must be installed on the computer that contains the content you want to play on the Home cinema. The mobile device must support Samsung Link. For more information, visit Samsung's content and service portal at <http://link.samsung.com>.
- You may experience compatibility issues when attempting to play media files via a third-party DLNA server.
- The content shared by a computer or a mobile device may not play depending on the encoding type and file format of the content. In addition, some functions may not be available.
- The media content may not play smoothly depending on the network status. If this occurs, use a USB storage device.

1. In the Home screen, select **MULTIMEDIA**, and then press the OK button.
  2. Select **Network Device** at the bottom of the screen, and then press the OK button. Storages devices connected to the same network as the Home cinema are listed.
  3. Select a storage device, and then press the OK button. The folders and files shared by the selected storage device are listed.
  4. If necessary, use the **^V<>** buttons to select a folder, and then press the OK button.
  5. Select a file to view or play, and then press the OK button.
  6. Press the **⏪** (RETURN) button to exit a folder or the **⏩** (EXIT) button to return to the Home screen.
  7. Go to pages 29~41 for instructions that explain how to control playback of videos, music, and pictures on a storage device.
- 📎 To list only one type of media file, use the **Filter**(**∇**) function in the top-right corner of the item or device screen.
  - 📎 In the **Filter**(**∇**) drop down, select **Photos**, **Videos**, or **Music**.
  - 📎 Even though the product will display folders that contain all content types, it will only display files of the content type you selected. For example, if you selected **Music**, you will only be able to see music files.
  - 📎 Alternatively, move to the media content to play and press the OK button to play the content.

## Playing Media Content Saved in a Cloud Service

Dropbox and SkyDrive and other cloud services save user content such as photos, videos, and music files on a remote server accessible through the Internet. When your home cinema is connected to the Internet, you can view or play the media content saved in a cloud service through the home cinema.

- 📎 To play the content in a cloud service, you must log into your Samsung account and link the Samsung account to the cloud service account. For the information about linking your Samsung account to a cloud service account, refer to the "Logging In to Your Samsung Account" section.

1. In the Home screen, move to **MULTIMEDIA** and press OK button.
2. Select **Storage Service** at the bottom of the screen.
3. The cloud services linked with your Samsung account appear.
4. Select a cloud service. The folders and files in the selected cloud service are listed.
5. If necessary, use the **^V<>** buttons to select a folder, and then press the OK button.
6. Select a file to view or play, and then press the OK button.
7. Press the **⏪** (RETURN) button to exit a folder or the **⏩** (EXIT) button to return to the Home screen.
8. Go to pages 29~41 for instructions that explain how to control playback of videos, music, and pictures located in a **Storage Service**.

## Controlling Video Playback

You can control the playback of video content located on a Blu-ray/DVD disc, USB device, mobile device, or PC. Depending on the disc or contents, some of the functions described in this manual may not be available.

## Buttons on the Remote Control used for Video Playback

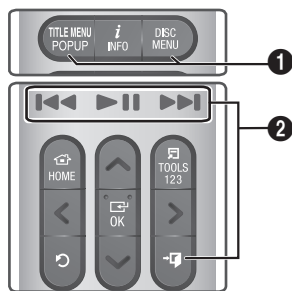

- 1 Using the disc menu, title menu, popup menu, and title list

### DISC MENU

During playback, press this button to display the Disc menu.

# Playing Content

## TITLE MENU

During playback, press this button to display the Title menu or Popup menu.

- If your disc has a playlist, press the **Sort By** button to go to the playlist.

## 2 Playback related buttons

The product does not play sound in Search, or Slow mode.

- To return to normal speed playback, press the **▶||** button.

|                         |  |
|-------------------------|--|
| <b>▶  </b>              | Starts/Pauses playback.  |
| <b>-   (EXIT)</b>       | Stops playback.  |
| <b>Fast Motion Play</b> | During playback, press and hold the <b>◀◀</b> or <b>▶▶</b> button. Each time you press and hold the <b>◀◀</b> or <b>▶▶</b> button, the playback speed will change.       |
| <b>Slow Motion Play</b> | In pause mode, press and hold the <b>▶▶</b> button. Each time you press and hold the <b>▶▶</b> button, the playback speed will change.                                   |
| <b>Skip Motion Play</b> | During playback, press the <b>◀◀</b> or <b>▶▶</b> button. Each time you press the <b>◀◀</b> or <b>▶▶</b> button, the disc moves to the previous or next chapter or file. |

## Using the TOOLS Menu

### Commercial Discs

During playback, press the **TOOLS** button.

### File-based Video

During playback, press the **TOOLS** button.

Use the **<>** buttons to select **Settings** (⚙️) in the upper right corner, and then press the **OK** button.

## Play from the beginning

Select to return to the beginning of the movie, and then press the **OK** button.

## 3D

Use **3D** menu to select the **Side by Side** or **Top Bottom** option if the 3D content currently playing does not appear properly in 3D mode.

- 📎 Use **3D** menu for 3D content only. If you apply the **Side by Side** or **Top Bottom** format to 2D content, it will not be displayed properly.

## Select Scene

You can use the **Select Scene** function during playback to view or start a movie from the scene of your choice.

- 📎 If the index information in the file is damaged or the file does not support indexing, you will not be able to use the **Select Scene** function.

- 📎 If you are using the DLNA function after connecting to a computer through your network, **Select Scene** may not be supported.

✓ **Search Titles** : If there is more than one movie on the disc or device, select to start a different title.

1. Select **Search Titles**, and then press the **OK** button.
2. Use the **▲▼** buttons to select a title, and then press the **OK** button.

✓ **Chapter Search** : Select to play the chapter of your choice.

1. Select **Chapter Search**, and then press the **OK** button.
2. Use the **▲▼** buttons to select a chapter, and then press the **OK** button.

✓ **Search Time Bar** : Select to play the movie from a selected time point.

1. Select **Search Time Bar**, and then press the **OK** button.
2. Press and hold the **123** button until the Num pad appears on the screen. When the Num pad appears, select a number using the **▲▼<>** button and then press the **OK** button.

- 📎 You can also use the **<>** buttons to advance or rewind the movie. The movie advances or rewinds one minute each time you press the **<>** buttons.

## Repeat Mode

Lets you repeat a title, chapter, or specific section.

- **Off** : Select to return to normal playback.
- **Title** : Choose to repeat a selected title.
- **Chapter** : Choose to repeat a specific chapter.
- **Repeat A-B** : Choose to repeat a specific section.

1. Press the OK button at the point where you want repeat play to start (A).
2. Press the OK button at the point where you want repeat play to stop (B).

 Depending on the disc, the screen may not display all repeat options.

 **Off**, **Repeat One**, and **Repeat All** appear when you play a video recorded as a digital file.

 The screen may not display **Chapter** or **Title** immediately. Continue to press the **▲▼** buttons until your choice is inside the applicable field.

 The screen may not display **Repeat A-B** immediately. Continue to press the **▲▼** buttons until **Repeat A-B** is inside the applicable field.

 You must set point (B) at least 5 seconds of playing time after point (A).

## Picture Mode

Lets you set the **Picture Mode**.

- **Dynamic** : Increases sharpness and brightness.
- **Standard** : Choose this setting for most viewing applications.
- **Movie** : The best setting for watching movies.
- **User** : Lets you adjust the sharpness and noise reduction function respectively.

 When you use the **BD Wise** function, this menu will not appear.

## Equaliser Mode

Set Equalizer Mode on to use the equalizer.

## Equaliser Settings

Lets you set the equalizer.

 Equaliser Settings only appears when **Equaliser Mode** is On.

## Audio

Select to set the desired audio language.

## Audio Sync

In some cases when the product is connected to a digital TV, the audio signal may not synchronize with the video signal. If this occurs, use Audio Sync to adjust the audio delay time to match the video signal.

## Subtitle

Lets you set the desired subtitle language.

## Subtitle Settings

Lets you set the desired subtitle options.

## Angle

To view a scene from another angle. The **Angle** option displays the number of angles available to view (1/1, 1/2, 1/3, etc.).

## BONUSVIEW Video

## BONUSVIEW Audio

Lets you set the desired Bonusview option.

## Rotate



You can rotate the screen clockwise or counterclockwise by 90 degrees.

## Full Screen

Lets you set the size of the video image. Choose **Original**, **Mode1** (larger), or **Mode2** (largest).

## Information

Select to view video file information.

-  Depending on the disc or storage device, the Tools menu may differ.
-  Video files with high bitrates of 20Mbps or more strain the product's capabilities and may stop playing during playback.

# Playing Content

## Using the Sort By & Options Menus

Select the **Filter** (▼) function, and then **Videos** to display videos only.

- Even though the product will display folders that contain all content types, it will only display files of the content type you selected. For example, if you selected **Videos**, you will only be able to see video files.

On the screen that lists the video files, use the **^** **v** **<** **>** buttons to select **Sort By** or **Options** in the upper right, and then press the **OK** button.

### Videos

#### Sort By

- Date**  
Displays all the folders with videos by date. If you select a folder, and then press **OK** button, displays all the video files in the folder by date.
- Title**  
Displays all the video files on the media or storage device by title.
- Folder**  
Displays all the folders on the media or storage device.

### Options

- Play Selected**  
**Play Selected** lets you create a playlist by selecting specific files to play. It works essentially the same way for all media. See "Using Play Selected with a Commercial CD" on page 35.
- Send**  
Select **Send** to upload selected files to on-line sites (Picasa, Facebook, etc.) or to devices. To use **Send** with an on-line site, you need to establish an account with the on-line site, and then log in using the **Log In** function. **Send** works essentially the same way for music, photos, and videos. For general instructions, see "Using the Send Function" on page 41.

- Depending on the disc or storage device, the **Options** and **Sort By** menus may differ. All options may not be displayed.

- The **Sort By** and **Options** menus are usually available when you are viewing video files on a USB flash drive, a PC, a disc you recorded yourself, or a mobile device. They are usually not available if you are viewing a commercial Blu-ray, DVD, or CD disc.

## Controlling Music Playback

You can control the playback of music content located on a DVD, CD, USB, mobile device, or PC. Depending on the disc or contents, some of the functions described in this manual may not be available.

### Buttons on the Remote Control used for Music Playback

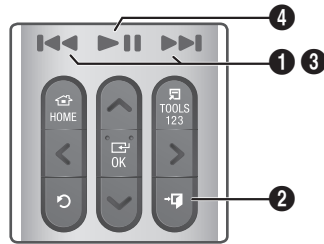

|   |   |
|---|---|
| 1 | ◀◀ ▶▶ buttons : Move to the previous/next track.  |
| 2 | ➤ (EXIT) button : Stops a track.  |
| 3 | <b>Fast Play (Audio CD [CD-DA] only)</b><br>During playback, press and hold the ◀◀ or ▶▶ button.<br>Each time you press and hold the ◀◀ or ▶▶ button, the playback speed will change. |
| 4 | ▶▶ button : Plays/Pause a track.  |

## Music Screen Controls



The Track List screen appears initially, and the first track begins to play. If you are playing a commercially recorded disk and don't press a button on the remote momentarily, the Playback screen appears. To return to the Track List screen, press the **↻** (RETURN) button.

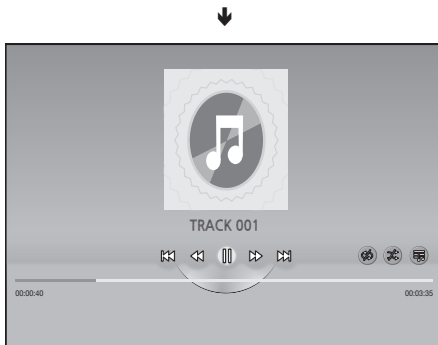

On the Track List screen, use **▲▼** buttons to move the highlight to the track you want. Press the OK button to play the track.

## On Screen Music Controls

|  |                             |
|--|-----------------------------|
|  | Pause a track.              |
|  | Play a track.               |
|  | Move to the previous track. |
|  | Move to the next track.     |

|  |   |
|--|---|
|  | Rewind the track.   |
|  | Advance the track.  |
|  | Repeat one track or all tracks.   |
|  | Play tracks in random order.  |
|  | Display the Equaliser.  |
|  | <ul style="list-style-type: none"> <li>✓ <b>Equaliser Settings</b> : Adjust the equalizer manually. (Available only when <b>Equaliser Mode</b> is on)</li> <li>✓ <b>Play Selected</b> : <b>Play Selected</b> lets you select specific files to play. It works essentially the same way for all media. See "Using Play Selected with Self-Recorded Media (CDs, USB Devices, etc.)" on page 35.</li> <li>✓ <b>Ripping</b> : The Ripping function converts CD audio to the mp3 format and saves the converted files on a USB device or a mobile device connected to the product. See Ripping on page 37.</li> <li>✓ <b>Information</b> : Shows the track information.</li> </ul> |

On the Music List screen only.

To access the controls, play a track, and then use the **▲▼<>** buttons to move to the control of your choice.

- The music screen controls are only accessible when a track is playing.
- All controls do not appear at the same time.
- For file-based contents, the available **Settings** () options will differ.

## Using the Sort By & Options Menus

Select the **Filter**() function, and then **Music** to display music files only.

- Even though the product will display folders that contain all content types, it will only display files of the content type you selected. For example, if you selected **Music**, you will only be able to see music files.

# Playing Content

On the screen that lists the music files, use the **^V<>** buttons to select **Sort By** or **Options** in the upper right, and then press the **OK** button.

## Music

### Sort By

- **Track**  
Displays all the music tracks on the media or storage device.
- **Album**  
Displays all the music on the media or storage device by album.
- **Artist**  
Displays all the music files on the media or storage device by artist
- **Genre**  
Displays all music on the media or storage device by genre.
- **Folder**  
Displays all the folders on the media or storage device.

## Options

- **Play Selected**  
**Play Selected** lets you select specific files to play. It works essentially the same way for all media. See "Using Play Selected with a Commercial CD" on page 35 and "Using Play Selected with Self-Recorded Media (CDs, USB Devices, etc.)" on page 35.
- **Send**  
Select **Send** to upload selected files to on line sites (Picasa, Facebook, etc.) or to devices. To use **Send**, you need to establish an account with the on-line site, and then log in using the Log In function. **Send** works essentially the same way for music, photos, and videos. For general instructions, see "Using the Send Function" on page 41.
- **Encoding**  
Select to manage the text encoding options.
- **Rename Playlist**  
Lets you modify the name of a playlist.
- **Delete Playlist**  
Lets you delete a playlist.
- **Add to Playlist**  
Lets you add additional files to a playlist.

- ✎ Depending on the disc or storage device, the **Options** menu may differ. All options may not be displayed.
- ✎ **Rename Playlist** and **Delete Playlist** appear only if a playlist exists.

## Repeating Tracks on an Audio CD

You can set the product to repeat tracks on an audio CD (CD-DA/MP3).

1. On the Track List screen during playback, use the **^V<>** buttons to select  in the lower left corner of the screen, and then press the **OK** button.
2. Use the **^V** to select the Repeat mode you want - **Off**, **One Song**, or **All** - and then press the **OK** button.



Track List screen

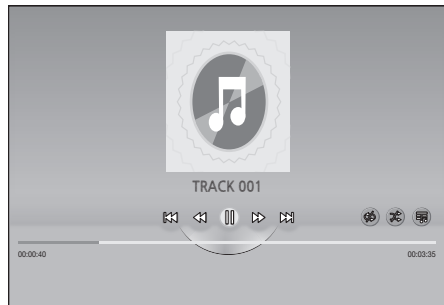

Playback screen



Press the **▷** (**RETURN**) button on the remote to return to the Track List screen.

## Shuffling Tracks on an Audio CD

You can set the product to play tracks on an audio CD (CD-DA/MP3) at random.

1. During playback, use the **▲▼<>** buttons to select  in the lower left corner of the screen, and then press the OK button.
2. Use the **▲▼** to set the **Shuffle** mode **Off** or **On**, and then press the OK button.

## Using Play Selected with a Commercial CD

1. On the Track List screen, select **Settings** () on the bottom left, and then press the OK button. The **Settings** menu appears.
2. Select **Play Selected**, and then press the OK button. The **Play Selected** screen appears.
3. Use the **▲▼** buttons to select a track, and then press the OK button. A check appears to the left of the track.
4. Repeat Step 3 to select and check additional tracks.
5. To remove a track from the list, move to the track, and then press the OK button again. The check on the track is removed.
6. When done, select **Play** on the bottom left, and then press the OK button. The Track List screen reappears listing only the tracks you checked. The selected tracks play automatically.
7. To cancel the **Play Selected** list, select **Settings** () on the bottom left of the Track list screen. On the Settings menu select **Play All**. The Track List screen reappears with all tracks on the CD listed.

 You can select up to 99 tracks from an Audio CD (CD-DA) using Play Selected.

 On the **Play Selected** screen, you can also choose **Select All**, **Clear All**, and **Cancel**.

- Use **Select All** to select all tracks. This cancels your individual track selections. When you press the **⏮** (RETURN) button on your remote or select **Play** and then press the OK button, all tracks will appear on the Track List screen, and the product will begin to play all tracks from Track 001.

- Use **Clear All** to deselect all selected tracks at once. Then, select individual tracks or use **Select All** to select all the tracks, and then press the **⏮** (RETURN) button on your remote or select **Play** and then press the OK button. If you do not use **Select All** or select individual tracks, the **Play Selected** list will not change.
- **Cancel** cancels any changes you made on the **Play Selected** screen. When you return to the Track List screen, the **Play Selected** list will be unchanged.

## Using Play Selected with Self-Recorded Media (CDs, USB Devices, etc.)

1. Insert a self-recorded CD or USB device with self-recorded files into the home cinema. The **New device connected**, pop-up appears.
2. Select **Music**, and then press the OK button on your remote. The File List screen appears displaying icons for tracks, folders, or both.
3. If necessary, use the **▲▼<>** buttons to select a folder, and then press the OK button.
4. When the tracks you want to play are displayed, select **Options** in the upper right, and then press the OK button.
5. Select **Play Selected**, and then press the OK button. Check boxes appear on the upper left sides of the track icons.
6. Use the **▲▼<>** buttons to select a track, and then press the OK button. A check appears in the check box.
7. Repeat Step 6 to check and select additional tracks.
8. To remove a track from the list, move to the track, and then press the OK button again. The check on the track is removed.
9. When done, select **Play**, and then press the OK button. The Track List screen appears listing only the tracks you checked. The selected tracks play automatically.
10. To cancel the **Play Selected** list, press the **⏮** (RETURN) button or the **▶⏮** (EXIT) button. If you press **⏮** (RETURN), you return to the File List screen. If you press **▶⏮** (EXIT), you go to the Home screen.

# Playing Content

- ✎ If you want to use **Play Selected** to watch videos, use the **Filter**(▼) function to select **Videos** instead of **Music**.

## Using Play Selected Starting from the Home Screen

- ✎ Select **PLAY DISC** or **MULTIMEDIA** depending on the media you are using.
  - If you selected **PLAY DISC**, the Track List screen appears. Use the **Filter**(▼) function to select **Music**, and then follow the directions starting at Step 3 above.
  - If you selected **MULTIMEDIA**, select **Storage** or **Network Device** on the **MULTIMEDIA** screen. Then, select your storage media on the **Storage** screen or device on the **Network Device** screen. The File List screen appears. Use the **Filter**(▼) function to select **Music**, and then follow the directions starting at Step 3 above.

## Creating and Editing a Playlist Stored in a Storage Device

### Creating a playlist

1. Connect a USB device with stored music to the home cinema's USB jack, and then turn on the home cinema.
2. On the Home screen, select **MULTIMEDIA**, and then press the OK button.
3. On the **MULTIMEDIA** screen, select **Storage**, and then press the OK button.
4. Select the USB device, and then press the OK button.
5. At the top of the screen, select **Filter**(▼) → **Music**.
6. After the screen re-displays, select **Options** (⚙) → **Add to Playlist**.
7. On the next screen, select an existing playlist, and then press the OK button.  
**OR**  
Select **New Playlist**, and then press the OK button. If you selected an existing playlist, go to Step 9. If you selected **New Playlist**, go to Step 8.



8. On the on-screen keyboard, accept the default name for the new playlist or enter a new name. When finished, select **Done**, press OK, and then go to Step 9.
9. Navigate to the screen that displays the music you want to put into the playlist.
10. Use the ^ v < > buttons to select a track, and then press the OK button. A check appears in the check box on the left side of the track icon.
11. Repeat Step 10 to check and select additional tracks.
12. To remove a track from the list, move to the track, and then press the OK button again. The check on the track is removed.
13. When finished, select **Add** at the top of the screen, and then press the OK button. The playlist is saved to the USB device and the **Added** pop-up appears. Press the OK button.

### Playing a playlist



1. Connect the USB device with the playlist to the home cinema's USB port.
2. Navigate to the playlist (Home screen → **MULTIMEDIA** → **Storage** → USB device → playlist).
3. Select the playlist, and then press OK. The Track List screen appears and the first track of the playlist starts to play.

### Editing a playlist

1. While playing a playlist, select **Settings** (⚙) → **Edit Playlist** at the bottom-left corner of the Track List screen.
  2. Use the ^ v < > buttons to select a track, and then press the OK button. A check mark appears next to the track.
  3. To cancel a selection, select the track again, and then press the OK button.
- ✎ To select all tracks at once, use **Select All**. To cancel all selections at once, use **Deselect All**.

4. When finished, select **Delete** at the bottom left of the screen, and then press the **OK** button.  
A confirmation pop-up appears.
  5. Select **Yes**, and then press the **OK** button.
  -  Deleting all files included in a playlist will delete the playlist itself, too.
  -  You can save up to 5 playlists.
10. If you want to cancel ripping after ripping has begun, press the **OK** button and then select **Yes**. Select **No** to continue ripping.
  11. When ripping is complete, the "**Successfully ripped.**" message appears. Press the **OK** button. The Track List screen reappears.

## Ripping

1. Insert a USB device into the USB jack on the front of the product. This is the device you will rip the files to.
2. Put a music CD into the home cinema. In a few moments, the Track List screen appears.
3. On the Track List screen, select **Settings** () on the lower left of the screen, and then press the **OK** button. The Settings menu appears.
4. Use the **▲▼** buttons to select **Ripping**, and then press the **OK** button. The Ripping screen appears.
5. Use the **▲▼** buttons to select a track, and then press the **OK** button. A check appears to the left of the track.
6. Repeat Step 5 to select and check additional tracks.
-  To select all tracks at once, select **Select All** on the bottom left of the screen, and then press the **OK** button.
7. To remove a track from the list, move to the track, and then press the **OK** button again. The check on the track is removed.
8. When done, select the **Rip** button using the **▲▼** buttons, and then press the **OK** button. The Rip pop-up appears.
9. Use the **▲▼** buttons to select the device to store the ripped files to, and then press the **OK** button. Ripping begins.
-  Do not disconnect the device while ripping is in progress.

## Using Bluetooth

You can use a Bluetooth device to enjoy music with high quality stereo sound, all without wires!

### What is Bluetooth?

Bluetooth is a technology that enables Bluetooth-compliant devices to interconnect with each other easily using a short, wireless connection.

- A Bluetooth device may hum or malfunction:
  - When a part of your body is in contact with the receiving/transmitting system of the Bluetooth device or the Home Cinema.
  - When it is subject to electrical variation from obstructions caused by a wall, corner, or office partitioning.
  - When it is exposed to electrical interference from same frequency-band devices including medical equipment, microwave ovens, and wireless LANs.
- Pair the Home Cinema with the Bluetooth device while the two are close together.
- The further the distance is between the Home Cinema and the Bluetooth device, the worse the quality is.  
If the distance exceeds the Bluetooth operational range, the connection is lost.
- In poor reception areas, the Bluetooth connection may not work properly.

# Playing Content



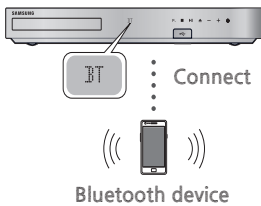

- The Home Cinema has an effective reception range of up to 10 meters in all directions if there are no obstacles. The connection will be automatically cut off if the device is out of this range. Even within this range, the sound quality may be degraded by obstacles such as walls or doors.
- This wireless device may cause electrical interference, during its operation.

## To connect the Home Cinema to a Bluetooth device



Before you begin, confirm that the Bluetooth device supports the Bluetooth compliant stereo headset function.

1. Press the **SOURCE** button on the remote control to display the **BT** message.
  2. Select the Bluetooth menu on the Bluetooth device you want to connect. For instructions, refer to the Bluetooth device's manual.
  3. Select the Stereo headset menu on the Bluetooth device.
    - You will see a list of devices.
  4. Select "[HTS]Hxxxxx" from the searched list.
    - When the Home Cinema is connected to the Bluetooth device, the device name of the connected Bluetooth device, followed by the name of home cinema will appear on the front display of home cinema.
  5. Play music on the connected device.
    - You can listen to the music playing on the connected Bluetooth device over the Home Cinema system.
-  The Home Cinema only supports Middle Quality SBC data (up to 237kbps@48kHz), and does not support High Quality SBC data (328kbps@44.1kHz).

-  The AVRCP feature is supported. It's functionality will differ, depending on the specifications of the connected device.
-  Connect only to a Bluetooth device that supports the A2DP Profile.
-  Only one Bluetooth device can be paired at a time.
-  The search or connection functions may not work properly in the following cases:
  - If there a strong electric field near or around the home cinema.
  - If several Bluetooth devices are simultaneously paired with product.
  - If the Bluetooth device is turned off, not in place, or malfunctions.
  - Note that such devices as microwave ovens, wireless LAN adapters, fluorescent lights, and gas stoves use the same frequency range as the Bluetooth device, and can cause electric interference.
-  For a more reliable connection to a Bluetooth device or to other devices such as a smart phone, we recommend you update the device's software to the most current version.

## To disconnect the Bluetooth device from the Home Cinema

You can disconnect the Bluetooth device from the Home Cinema. For instructions, refer to the Bluetooth device's manual.

- When the Home Cinema is disconnected from the Bluetooth device, the Home Cinema will display **DISCONNECTED** on the front display.

## To disconnect the Home Cinema from the Bluetooth device

Press the **(F.)** button on the front panel of the Home Cinema to switch from **BT** to another mode or turn off the Home Cinema.

- Except when you disconnect the Home Cinema by changing functions, the connected Bluetooth device will wait a certain time for a response from the Home Cinema before terminating the connection. (Disconnection time may differ, depending on the Bluetooth device.)

- ✎ In Bluetooth connection mode, the Bluetooth connection will be lost if the distance between the Home Cinema System and the Bluetooth device exceeds 10 meters. When the Bluetooth device comes back into effective range or you restart the Bluetooth device, you have to pair the device and home cinema again to reconnect.
- ✎ In Bluetooth mode, the screen saver will start if the Bluetooth device stays in the Ready state for 5 minutes. To reconnect the Bluetooth device, turn off the screen saver, and then connect the device. To turn off the screen saver, press any button on the remote control (the Volume button, an **▲▼<>** buttons, etc.).

## Using Bluetooth Power On

When the home cinema is turned off, connecting a previously connected smart device to the product via a Bluetooth connection can turn the home cinema on.

- ✎ The home cinema must be plugged in for **Quick Start** to work.
  - ✎ To use this function, set **Settings > System > Quick start to On**.
  - ✎ To use this function, the Bluetooth connection between the Home cinema and your smart device must have been established previously, and the Home cinema must be on your smart phone's list of known Bluetooth devices.
1. Connect your previously connected smart device to the product via Bluetooth. (For information on Bluetooth connections, refer to your smart device's manual.)
  2. Once connected, the home cinema turns itself on automatically in **BT** mode.
    - Select the desired music to play on your smart device.

## Using NFC (Near Field Communication)

Connect your NFC compatible device via Bluetooth to the Home Cinema using this simple set-up procedure. You can play music from the smart phone through the Home Cinema.

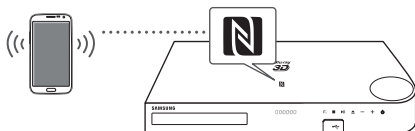

1. Turn on the NFC function on the smart phone and make sure the screen lock function on the smart phone is off. The smart phone's NFC function will not work if screen lock is on.
  2. Gently touch the NFC logo **N** on the top of the Home Cinema with the NFC supported device.
    - If the Home Cinema is off, it will turn on automatically.
  3. A pop-up asking whether to proceed with the Bluetooth connection appears on the smart phone. Select 'Yes'.
    - When the connection is complete, the 'connected' message appears.
  4. To disconnect the NFC device, touch the device to the Home Cinema's top panel again.
    - To connect another NFC device while the first smart phone is still connected, touch that device to the Home Cinema's top panel. The Home Cinema will disconnect the first smart phone and connect to the second smart phone.
- ✎ The NFC function is built into Android devices running Android OS 4.1 Jellybean or later.
    - If your device is running an Android OS earlier than Android OS 4.1 Jellybean, you must download the 'Samsung NFC Connection' application from Android market to use the NFC function.
  - ✎ The position of the NFC antenna differs on smart phones. Check where the NFC antenna is located before connecting. Refer to the user manual of your mobile phone to check the antenna's location before making the connection.
  - ✎ If your smart phone is covered with a thick case, the connection may not succeed.
  - ✎ The **N** is a trademark or registered trademark of NFC Forum, Inc. in the United States and in other countries.
  - ✎ NFC tagging for Bluetooth connection cannot be established while powering on and off.
  - ✎ NFC tagging for Bluetooth connection will not work while the battery indicator is blinking.

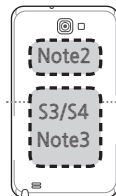

# Playing Content

## Playing Photo Contents

You can play photo contents located on a DVD, USB, mobile device, or PC.

### Using the Tools Menu

While displaying a photo, press the **TOOLS** button on the remote.

Select **Settings** (⚙️) in the upper right corner of the screen, and then press the **OK** button. The Tools menu drop down list appears.

#### Slideshow Settings

- **Speed** : Select to set a slide show's speed.
- **Effects** : Select to set a slide show's special effects.

#### Rotate

Select to rotate the picture. (This will rotate the picture either clockwise or counter clockwise.)

#### Zoom

Select to enlarge the current picture. (Enlarge up to 4 times)

#### Picture Mode

- **Dynamic** : Choose to increase sharpness.
- **Standard** : Choose for most viewing applications.
- **Movie** : This is the best setting for watching movies.
- **User** : Lets you adjust the sharpness and noise reduction function respectively.

#### Background Music

Select to listen to music while viewing a slide show.

#### Equaliser Mode

Set to **On** to use the equalizer. Customize your own personal sound preferences using the equalizer settings.

#### Equaliser Settings

This function is only available when **Equaliser Mode** is **On**.

## Send

Select **Send** to upload selected files to on-line sites (Picasa, Facebook, etc.) or devices. To use **Send** with an on-line site, you need to establish an account with the on-line site, and then log in using the **Log In** function. **Send** works essentially the same way for music, photos, and videos. For general instructions, see "Using the Send Function" on page 41.

## Information

Displays the picture information.

- 🔍 Depending on the disc or storage device, the **Options** menu may differ. All options may not be displayed.
- 🔍 To enable the **Background Music** function, the photo file must be in the same storage media as the music file. However, the sound quality can be affected by the bitrate of the MP3 file, the size of the photo, and the encoding method.
- 🔍 You can't enlarge the subtitle and PG graphic in the full screen mode.

## Using the Sort By and Options Menus When the Photo File List is Displayed

Select the **Filter** (▼) function, and then **Photos** to display photos only.

- 🔍 Even though the product will display folders that contain all content types, it will only display files of the content type you selected. For example, if you selected **Photos**, you will only be able to see photo files.

On the screen that lists the photo files, use the **^ v <>** buttons to select **Sort By** or **Options** in the upper right, and then press the **OK** button.

### Photos

#### Sort By

- **Date**  
Groups all the photo files on the media or storage device by date. Click a group to see the photos in that group.
- **Title**  
Displays all the photo files on the media or storage device by title.
- **Folder**  
Displays all the folders on the media or storage device.

## Options

### ■ Slide Show

Starts the slide show. Shows all the files in the current folder, one after another. If you want to create a slide show with a selected group of photos, see Play Selected below.

### ■ Play Selected

**Play Selected** lets you select specific files to play. It works essentially the same way for all media. See "Using Play Selected with Self-Recorded Media (CDs, USB Devices, etc.)" on page 35.

### ■ Send

Select **Send** to upload selected files to on line sites (Picasa, Facebook, etc.) or to devices. To use **Send** with an on-line site, you need to establish an account with the on-line site, and then log in using the Log In function.

 Depending on the disc or storage device, the **Options** menu may differ. All options may not be displayed.

## Using the Send Function

1. Use the **▲▼** buttons to select **Send**, and then press the OK button. The Selection screen appears.
2. Use the **▲▼** buttons to select a picture, and then press the OK button. A check appears to the left of the picture.
3. Repeat Step 2 to select and check additional pictures.
4. To remove a picture from the list, move to the picture, and then press the OK button again. The check on the picture is removed.
5. When done, press the **▲▼** button to select **Send**, and then press the OK button. The Send pop-up appears listing the on-line sites (Picasa, Facebook, etc.) or devices that you can send the photos to.
6. Select a destination, and then press the OK button.
7. If you are sending the photos to an on-line site, the site starts. Log in and follow the directions on the screen.

 To send photos to an on-line site, you must have an account with that site.

## Listening to the Radio

- To listen to the radio, you must connect the supplied FM antenna.

## Operating the Radio with the Remote Control

1. Press the **SOURCE** button to select **FM**.
2. Tune to the desired station.
  - Preset Tuning 1 : Press the **PRESET** button to select **PRESET**, and then press the **▲▼** buttons to select a preset station.
    - Before you can tune to preset stations, you must add preset stations to the product's memory.
  - Manual Tuning : Press the **PRESET** button to select **MANUAL**, and then press the **▲▼** buttons to tune to a lower or higher frequency.
  - Automatic Tuning : Press the **PRESET** button to select **MANUAL**, and then press and hold the **▲▼** buttons to automatically search the band.

## Setting Mono/Stereo

Press the **ST/MO** button.

- Each time you press the button, the sound switches between **STEREO** and **MONO**.
- In a poor reception area, select **MONO** for a clear, interference-free broadcast.

## Presetting Stations

Example : Presetting FM 89.10 into memory.

1. Press the **SOURCE** button to select **FM**.
2. Press the **▲▼** buttons to select <89.10>.
3. Press the **MEMORY** button.
  - **NUMBER** flashes on the display.
4. Press the **MEMORY** button again.
  - Press the **MEMORY** button before **NUMBER** disappears from the display on its own.
  - After you press the **MEMORY** button, **NUMBER** disappears from the display and the station is stored in memory.

# Playing Content

- To preset another station, repeat steps 2 to 4.
  - To tune to a preset station, press the **PRESET** button to select **PRESET**, and then press the **▲▼** buttons to select the preset station.

## Using the Special Effects Remote Control Buttons

### SOUND EFFECT Function



Lets you select a mode that optimizes the sound.

- Press the **SOUND EFFECT** button.
- Press the **▲▼** buttons to select the desired mode: **DSP**, **Virtual Surround**, **SFE Mode**, or **Sports**.
- Press the **<>** buttons to select the desired sound effect.

#### □ DSP

- ▼ **MP3 Enhancer** : Helps enhance your sound experience (ex. mp3 music). You can upscale your MP3 level sound (24 kHz, 8bit) to CD level sound (44.1 kHz, 16bit).
- ▼ **Power Bass** : Increases the volume level of bass tones and provides thudding sound effects.
- ▼ **Virtual 7.1** (HT-H7500WM only) : Creates a virtual 7.1 CH sound using the 5.1 CH speaker system.
- ▼ **Off** : Select for normal listening.

#### □ Virtual Surround

You can set a two-channel input source to produce sound in 5.1 channel surround mode.

#### □ SFE Mode

- ▼ **Symphony Hall in Boston (Hall 1)** : Provides a clear vocal as if listening in a concert hall.
- ▼ **Philharmonic Hall in Bratislava (Hall 2)** : Also provides a clear vocal as if listening in a concert hall, but less powerful than HALL1.
- ▼ **Jazz Club in Seoul B** : Recommended setting for Jazz.
- ▼ **Church in Seoul** : Gives the feel of being in a grand church.
- ▼ **Amphitheater (Rock)** : Recommended setting for Rock.
- ▼ **Off** : Select for normal listening.

#### □ Sports

- ▼ **Announcer** : Emphasizes the commentator's voice during a sports game to increase your absorption in the game.
- ▼ **Stadium** : Emphasizes spectators' cheering during a sports game to add immediacy.
- ▼ **Off** : Select for normal listening.

### DTS Neo:Fusion II / 3D Sound



You can enjoy more natural and vivid surround sound with enriched tones by adjusting the depth of sound using the level options.

- **DTS Neo:Fusion II** : **Off** → **On**
- **3D Sound** (HT-H7500WM only) : **Off** → **High** → **Low**
- 🔑 **3D Sound** is not available in **FM** mode.
- 🔑 The **3D Sound** is displayed only if you selected **Simple Speaker Setup** > **Simple Mode**.

# Network Services

You can enjoy various network services such as streaming video or on-line apps by connecting the product to your network.

To use network services, you must first:

1. Connect the product to a network. (See page 14)
2. Configure the network settings. (See pages 22~24)

## Logging In to Your Samsung Account



Before you access **FILMS AND TV SHOWS** or **SAMSUNG APPS**, we suggest you log in to your Samsung account.

 If you do not have a Samsung account, create one by selecting **Create Account**.

To create a Samsung account, follow these steps:



1. With the Home screen displayed, press the  button. The **Sign In** screen appears.
2. Select the ID field, and then press the OK button. The keyboard pop-up appears.
3. Using the keyboard, enter your e-mail address. When finished, select the **Done** button, and then press the OK button. The **Sign In** screen re-appears.
4. Select the Password field, and then press the OK button. The keyboard pop-up appears.
5. Using the keyboard, enter your password. When finished, select the **Done** button, and then press the OK button. The **Sign In** screen re-appears.
6. To make the log in process easier next time, select **Sign me in automatically**, and then press the OK button.
7. Select **Sign In**, and then press the OK button.
8. The **Samsung account Terms and Conditions** screen appears.
9. Select **I agree**, and then press the OK button.
10. Select an image you want to use to identify your account, and then press the OK button.
11. Select **Done**.

 If you selected **Sign me in automatically**, the next time you log in, the product will automatically enter your e-mail and password. All you need to do is select **Sign In**.

 If you press the  button after you have logged in, the **Sign In** screen appears. You can select **Link Accounts**, **Edit profile**, **Remove Account**, and **Sign out**.

## Adding a Credit Card

To add a credit card to your account, follow these steps:

1. Select the  in the upper right of the Home Screen, and then press the OK button. The Account **Sign In** screen appears.
2. Sign in to your account if you are not signed in. The Home Screen reappears. If you are already signed in, go to Step 4.
3. Select the  again, and then press the OK button. The Account **Sign In** screen appears.
4. On the Account **Sign In** screen, select **Edit profile**, and then press the OK button. The on-screen keyboard appears.
5. Enter your account password. When finished, select **Done**, and then press the OK button. The **Edit profile** screen appears.
6. Select **Add Card**, and then press the OK button. The Add Card pop-up appears.
7. Read the Add Card text, and then press the OK button. The **Add Card** screen appears.
8. Enter the requested credit card information. When done, select **Save**, and then press the OK button.

## Before Using FILMS AND TV SHOWS or SAMSUNG APPS

If you haven't set up Smart Hub, when you use **FILMS AND TV SHOWS** or **SAMSUNG APPS** for the first time, the product will ask you to perform the Smart Hub set up procedure.

1. On the Home screen, select either **FILMS AND TV SHOWS** or **SAMSUNG APPS**, and then press the OK button.
2. If you selected **FILMS AND TV SHOWS**, the Smart Hub pop-up appears asking if you want to set up Smart Hub. Select **Yes**, and then press the OK button. The Welcome screen appears.

# Network Services

3. Select **Start**, and then press the **OK** button. The Smart Hub Terms & Conditions, Privacy Policy screen appears.
  4. On the **Additional Services and Options** screen, you must review and agree to both the Smart Hub Terms and Conditions and the Privacy Policy to use Smart Hub.
  5. Scroll down, and then click the **View details** buttons to review the full documents.
-  You do not need to consent to the Supplemental Privacy Notice, but one or more Smart TV features or functionalities may not be available if you do not.
6. Select **I agree to all**, and then press the **OK** button. The Setup Complete screen appears. Press the **OK** button.

## Using FILMS AND TV SHOWS

Through the **FILMS AND TV SHOWS** screen, you can stream movies and TV shows and watch them on your TV.

To stream and watch most movies and TV shows, you need a Samsung account with a registered credit card. To register a card, see page 43.

-  Depending on your country, this menu function may not be supported.

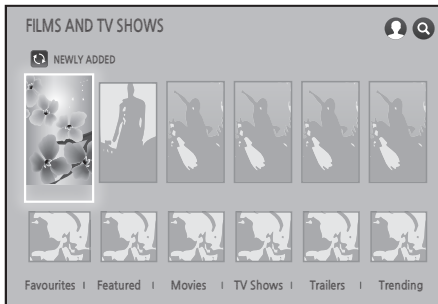

1. On the Home screen, select **FILMS AND TV SHOWS**, and then press the **OK** button.
2. Select one of the Recommended Movies or TV Shows, and then press the **OK** button. The Information screen for that movie appears.

-  As you highlight each movie or TV show, the icons for the apps you can use to stream the movie or show appear at the bottom of each movie or show selection icon.

- 2<sup>1</sup>. Alternately, select **Favourites**, **Featured**, **Movies**, **TV Shows**, **Trailers** or **Trending** and then press the **OK** button.

On the page that appears, use the **^V<>** buttons to select a show, movie, or trailer, and then press the **OK** button.

On the **Movies** or **TV Shows** screen, you can also select **What's New** or **Genres** to see more available shows or films. On the **Genres** screen, use the **^V<>** buttons to select a genres, and then press the **OK** button.

To make a selection on a page displaying movies or TV shows, use the **^V<>** buttons to make a selection, and then press the **OK** button.

3. If you have downloaded and installed one of the video streaming apps that you can use to stream the movie or show, select **Watch Now**, and then press the **OK** button. The app launches. Follow the directions on the screen to watch the movie or show you have chosen. If you have not downloaded one of the apps, go to Step 4.
  4. If you have not downloaded one of the video streaming apps, **Watch Via** appears on the screen instead of **Watch Now**. Select one of the video streaming apps to the right of **Watch Via**, and then press the **OK** Button.
  5. You will be asked if you want to install the app now. Select **Install**, press the **OK** button, and then follow the directions on the screen to install the app. You can also select **View Details** to view information about the app. The **View Details** screen lets you download the app as well.
  6. Once the app is installed, select **Play**, and then press **OK** to launch the app. Alternately, you can press the **↵** (RETURN) button to go back to the **FILMS AND TV SHOWS** screen, select the show or movie again, and then follow the directions in Step 3 to watch the movie or show.
-  Contents items and the corresponding bottom menu in **FILMS AND TV SHOWS** differ between countries.

- ④ On the each movie or show information screen, the **Watch Now** button is displayed only after you have download one of the video streaming apps you can use to stream that particular movie or show. **Watch Via** appears if you have not downloaded the necessary video streaming app. To the right of **Watch Via** is a listing of the video streaming apps you can use to stream the movie or show. Select an app icon to download and install the app.
- ④ **Favourites** will not appear unless you have tagged one or more films or TV shows as a favourites. To tag a movie or show as a favorite, select the show. The Detail screen appears. Select the heart symbol, and then press the OK button.

## Using SAMSUNG APPS

Through the **SAMSUNG APPS** screen, you can download applications from the Internet, and launch and run downloaded applications on your TV. To access some applications, you need to have a Samsung account.

- ④ While playing multimedia content in **SAMSUNG APPS**, press and hold **▶||** button on the remote to pause playback. To stop playback, press and hold **▶|■** (EXIT) button on the remote.

## The SAMSUNG APPS Screen at a Glance

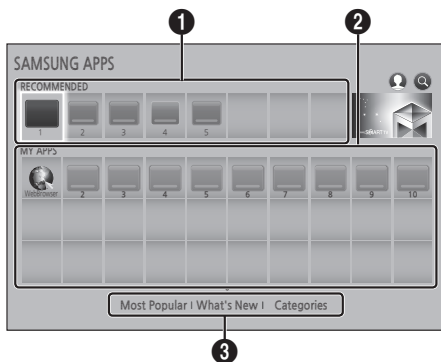

|          |  |
|----------|--|
| <b>1</b> | <b>RECOMMENDED</b> : Displays recommended contents managed by Samsung. You cannot delete Recommended Apps. |
| <b>2</b> | <b>MY APPS</b> : Displays your personal gallery of applications modifiable on the <b>MY APPS</b> screen.   |

|          |   |
|----------|---|
| <b>3</b> | <b>Most Popular, What's New and Categories</b> : Select to view and download additional apps. |
|----------|---|

The first time you open the **SAMSUNG APPS** screen, the Home cinema automatically downloads a group of free apps. Once these apps have been downloaded, they appear on the **SAMSUNG APPS** screen. To see additional apps, select **Most Popular, What's New, or Categories** on the bottom of the screen, and then press the OK button.

**Most Popular** displays the most popular apps, **What's New** the newest. **Categories** displays a series of icons representing categories such as **Video, Game, and Sports**. Select a category icon, and then press the OK button. The Home cinema displays the apps in that category.

## Downloading an App

1. Select **Most Popular, What's New, or Categories**, and then press the OK button.
2. If you selected **Categories**, select a category icon, and then press the OK button. Otherwise, go to Step 3.
- ④ On the **Most Popular, What's New, and Categories** screens, a green arrow is displayed on apps you have already downloaded.
3. Select an app you want to download, and then press the OK button. The Detail Information screen for the App appears.
4. Select the **Download** button on the screen, and then press the OK button. **Download** changes to **Cancel** and the app begins to download.
5. If you want to cancel the download, select **Cancel**, and then press the OK button.
6. When the download is complete, **Cancel** changes to **Play**. Select **Play**, and then press the OK button to start the application. Alternately, press the **↵** (RETURN) button until the **SAMSUNG APPS** screen reappears. The app you downloaded will be displayed on the App screen under **MY APPS**.

## Starting an Application

1. Select **SAMSUNG APPS** on the Home screen, and then press the OK button.
2. On the **SAMSUNG APPS** screen, use the **▲▼<>** buttons to select an app, and then press the OK button. The app starts.

# Network Services

## The Option Menu

The Option menu lets you add apps to and delete apps from **MY APPS**. It also lets you change the position of an app in **MY APPS** and update apps.

### Move

1. On the **MY APPS** screen, select the app you want to move, and then press the **OK** button for 3 seconds. The Option menu appears.
2. Select **Move**, and then press the **OK** button.
3. Use the **^v<>** buttons to move the app.
4. When the app is where you want it, press the **OK** or **EXIT** button.

### Delete

1. On the **MY APPS** screen, select the app you want to delete, and then press the **OK** button for 3 seconds. The Option menu appears.
2. Select **Delete**, and then press the **OK** button.
3. Use the **<>** buttons to select **OK**, and then press the **OK** button.

### Delete Multiple

1. On the **MY APPS** screen, select an app you want to delete and then press the **OK** button for 3 seconds. The Options menu appears.
2. Select the **Delete Multiple**, and then press the **OK** button.
3. Use the **^v<>** buttons to select apps you want to delete, and then press the **OK** button.
4. Use the **v** button to select **Delete**, and then press the **OK** button.

### View Details

1. On the **MY APPS** screen, select the app you want to see detailed information for, and then press the **OK** button for 3 seconds. The Option menu appears.
2. Select **View Details**, and then press the **OK** button.

### Change View

1. On the **MY APPS** screen, select an app, and then press the **OK** button for 3 seconds. The Option menu appears.

2. Select **Change View**, and then press the **OK** button. If the current view is Most Played, you will be asked if you want to change to Custom View. If the current view is Custom View, you will be asked if you want to change the view to Most Played. Most Played sorts the apps by the number of times you ran each app. Custom View lets you arrange the apps to your liking.
3. Select **OK**, and then press the **OK** button to change the view.

### Lock/Unlock

Locking an app makes it more difficult to delete accidentally.

1. On the **MY APPS** screen, select the app you want to lock, and then press the **OK** button for 3 seconds. The Option menu appears.
2. Select **Lock/Unlock**, and then press the **OK** button.
3. The PIN input pop-up appears. Enter your PIN. Press and hold the **123** button until the Num pad appears on the screen. When the Num pad appears, select a number using the **^v<>** button and then press the **OK** button. If you haven't set a PIN, enter the default PIN: 0000.
4. A checkbox appears on each app icon. Use the **^v<>** button to move to the app you want to lock, and then press the **OK** button to select it. A check mark appears on the icon.
5. Repeat Step 4 to select other apps. Use **Select All** or **Deselect All** on the bottom of the screen to select or deselect all apps at once. To deselect individual apps, select the app again, and then press the **OK** button. The check mark disappears.
6. When you have finished marking your selections, move to **Lock** on the bottom of the screen, and then press the **OK** button.
7. A lock mark appears on the selected app's icon. You will be prompted to enter the PIN number to delete or unlock a locked app.

### Update Apps

1. On the **MY APPS** screen, select any app, and then press the **OK** button for 3 seconds. The Option menu appears.
2. Select **Update Apps**, and then press the **OK** button.

3. The **Update Apps** screens lists all the apps that have updates available. Select each app you want to update, and then press the **OK** button. You can also choose **Select All** to update all the apps listed.
4. Select **Update**, and then press the **OK** button.

## Screen Mirroring

The **Screen Mirroring** function lets you view the screen of your smart phone or android tablet on the TV you have connected to the product.

1. In the Home screen, select **Screen Mirroring**, and then press the **OK** button.
2. Launch **AllShare Cast** or **Screen Mirroring** on your device.
3. On your device, find the name of the product in the list of available devices and then select it.
4. The TV displays a connecting message (for example, Connecting to Android\_92gb...) and then displays the connected message.
5. In a few moments, the screen of your device appears on the TV screen.
6. To stop **Screen Mirroring**, press the **EXIT** or **RETURN** button on the remote control, or exit the **Screen Mirroring** function on your smart phone.

 You can connect to a device that supports AllShare Cast. Note that all devices that have AllShare Cast may not be fully supported, depending on the manufacturer. For further information on mobile connection support, refer to the manufacturer's web site.

 When you are using the **Screen Mirroring** function, video stuttering or audio dropouts may occur, depending on your environment.

 Bluetooth transmissions can interfere with the **Screen Mirroring** signal. Before using the **Screen Mirroring** function, we strongly recommend that you turn off the Bluetooth function on your smart phone or smart device (tablet, etc.).

## Using the Web Browser

You can access the Internet using the Web Browser application.

1. Select **SAMSUNG APPS** on the Home screen and then press the **OK** button.

2. On the **SAMSUNG APPS** screen, select **WebBrowser**, and then press the **OK** button.

 When you run the Web Browser with the product connected by HDMI to a **BD Wise** compatible TV - and **BD Wise** is on - the browser is maximized to fill the screen and the TV's resolution is set to the optimal resolution automatically.

 The Web Browser is not compatible with Java applications.

 If you attempt to download a file, and the file cannot be saved, an error message will appear.

 E-commerce (purchasing products online) is not supported.

 ActiveX is not supported.

 Access may be blocked to some websites or to web browsers operated by certain businesses.

## Link Browsing and Pointer Browsing

The Web Browser provides two types of browsing, Pointer Browsing and Link Browsing. When you launch the browser for the first time, Pointer Browsing is active. If you are using a mouse to navigate in the Web Browser, we recommend leaving Pointer Browsing active. With Pointer Browsing, you move the pointer using the directional arrow keys on your remote. The pointer moves freely around the screen, much like the pointer on a computer when you use a mouse. With Link Browsing, you use the directional arrow keys to move a highlight from one link, button, or entry field to the next. The highlight is restricted to the links, buttons, and entry fields.

To activate Link Browsing, follow these steps:

1. Use the **▲▼<>** buttons on your remote to move the pointer to the Link Browser icon on the top right of the screen. The Link Browser icon is the third icon from the right. The pointer will be in the correct position if the icon turns blue and the words "Link Browsing" appear on the screen.
2. Press the **OK** button. Link Browsing is activated and will remain active whenever you bring up the Web Browser or until you change to Pointer Browsing.

# Network Services

## The Control Panel at a Glance

The Control Panel, which runs across the top of the screen, has a series of icons which start a number of useful functions. The icons are described below, starting with the icon on the far left of the screen.

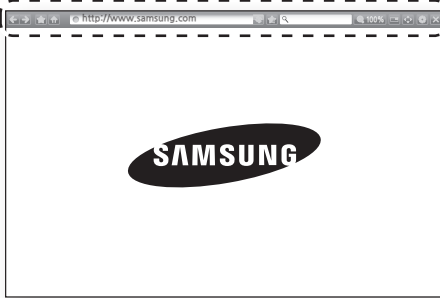

- : Moves to the previous page.
- : Moves to the next web page.
- : Displays the Bookmarks and History screen. You can bookmark the current page, select an existing bookmark, and edit and delete bookmarks. You can also view your browsing history and select a page to revisit.
- : Moves to the Home screen of the Web Browser.
- <http://www.samsung.com> : Lets you enter a page address manually using the keyboard pop-up.
- : Reloads the current page so that it is refreshed on the screen.
- : Adds the current page to your bookmarks.
- : Lets you search for information by entering words or characters using the keyboard pop-up. See Using the Keyboard Pop-up on this page.
- 100% : Lets you enlarge or shrink the screen by various percentages.
- / : Lets you switch between Pointer Browsing and Link Browsing.
- : Lets you configure the Browser's settings. See "Using the Settings Menu" on page 49.
- : Closes the Web Browser.

## Using the Keyboard Pop-up

When you click the <http://www.samsung.com>, the or access a data or text entry field, and then press the OK button, the keyboard pop-up appears.



To use the keyboard pop-up with your remote, follow these steps:

1. Use the  $\wedge \vee < >$  buttons on your remote to move the highlight to a letter or number of your choice.
2. Press the OK button to enter the letter or number into the entry field.
3. To access capital letters, move the highlight to the **Caps** key on the top left, and then press the OK button. Press the OK button again with the **Caps** key highlighted to access small letters again.
4. To access symbols and additional punctuation marks, highlight the **123#&** button on the left, and then press the OK button.
5. To delete a character you entered, move the highlight to the **←** button, and then press the OK button.
6. To delete all the characters you entered, move the highlight to the **Clear** button, and then press the OK button.
7. When finished entering, move the highlight to the **Done** button, and then press the OK button.

If you have a wireless keyboard connected to your product, you can use the wireless keyboard to enter letters, numbers, symbols, and punctuation. Note that the wireless keyboard will work only when the keyboard pop-up appears and can only be used to enter letters, numbers, symbols, and punctuation.

## Options on the Keyboard Pop-Up

To access the keyboard pop-up options, highlight the  button on the bottom left of the keyboard, and then press the OK button.

### Language

Select the language for the keyboard. You can select English, French, Russian, etc.

### Recommend text

The keyboard suggests recommended words as you enter text. You can turn this function **On** or **Off**.

### Reset recommended text data

Reset erases the Samsung Keyboard's memory. Select **OK** to erase everything that the Samsung Keyboard has learned about your writing style, including any new words you have used.

### Predict Next Letter

The keyboard will predict the next letter as you enter letters. The predictions appear in a ring around the letter you have just entered. You can select a predicted letter or move to another letter. You can turn this function **On** or **Off**.

### Accented Character Preview

Select if you want to type letters with accent marks.

## Using the Settings Menu

The Settings menu contains functions that control how the Browser operates and Browser security functions. To open the Settings menu, highlight the  icon in the Control Panel, and then press the OK button. To select an option in the Settings menu, highlight the option, and then press the OK button.



## Enable/Disable Grabbing

Turns the Grabber function on and off. When the Grabber function is on, you can move a web page up and down without dragging the scroll bar. The Grabber function is only available in Pointer Browsing.

## Approved Sites

Lets you restrict your children's access to inappropriate web pages by allowing access only to the web sites you have registered. Every time you access this function, the PIN screen appears. Press and hold the **123** button until the Num pad appears on the screen. When the Num pad appears, select a number using the **^v<>** button and then press the OK button. The first time you access this function, enter the default PIN, 0000.

You can change the PIN using the Reset password for the Approved Sites function. See below.

- **Approved Sites feature** : Turns the Approved Sites function on or off.
- **Reset password for Approved Sites** : Change the Approved Sites password.
- **Add current site** : Lets you add the currently displayed web site to the Approved Sites list.
- **Manage Approved Sites** : Lets you key in URLs to add to the Approved Sites List and delete sites from the Approved Sites list. If you turn this function on and have not added any sites to the Approved Sites list, you will not be able to access any Internet sites.

## Private browsing on/off

Enable or disable the Privacy mode. When the Privacy mode is enabled, the browser does not retain the URLs of sites you visit. If you want to enable Privacy mode, select **OK**.

If the Privacy mode is running, the "Stop" icon appears in front of the URL at the top of the screen. To disable Privacy mode, select it again when Privacy mode is enabled.

## Set Search Engine

You can set the desired Search Engine.

# Network Services

## Web Browser Settings

- **Set as homepage** : You can set the Browser's home page.
  - **Pop-up Block** : Turns the Pop-up Block on and off.
  - **Page Block** : You can determine whether to block advertisements and select the URLs for which advertisements are blocked.
  - **General** : You can delete personal information such as website history and browsing data (cookies, etc.), and reset all web browser settings to their factory defaults. You can also set the **Security Mode**.
-  Set the **Security Mode** to **On** to avoid accessing malicious/phishing sites and prevent malicious code from running.
- **Encoding** : You can set the Encoding setting for web pages to Automatic or select the encoding format manually from a list.
  - **Pointer** : You can set the speed of the cursor when the cursor is set to Pointer Browsing.
  - **Browser Information** : Displays the version number and copyright information for the Web Browser.

## Help

Provides basic information about the operation of the Web Browser.

-  Depending on the web site, some of the **Web Browser Settings** functions may not be activated. Functions that are not activated are greyed out and cannot be used.

## Linking your Internet Service Accounts to the Product

The Link Accounts function lets you link your product to your accounts with Internet services such as Pandora so that the product can log you in to the service automatically when you start the app for that service.

To create a service account link, follow these steps:

1. On the Home screen, select the  button in the upper right corner, and then press the OK button to log in to your Samsung Account.

2. After you have logged in, select the  button again, and then press the OK button.
3. Select **Link Accounts** in the My Account screen, and then press the OK button.
4. On the **Link Accounts** screen, select the service you want to link to the product, and then press the OK button.
5. In the ID and Password screen, enter the ID you use to log in to the service you selected using the pop-up keyboard. When finished, select **Done**, and then press the OK button.
6. Repeat the same process for the password. When finished select **Done**, and then press the OK button.
7. Select **OK**, and then press the OK button.

## BD-LIVE™

Once the product is connected to your network, you can enjoy various movie-related service contents available on BD-LIVE compliant discs.

1. Attach a USB flash drive to the USB jack on the front of the product, and then check its remaining memory. The memory device must have at least 1GB of free space to accommodate the BD-LIVE services.
2. Select **Settings** on the Home screen, and then press the OK button.
3. Select **Network**, and then press the OK button.
4. Select **BD-Live Settings**, and then press the OK button.
5. Select **BD Data Management**, and then press the OK button.
6. Select **Select Device**, and then press the OK button.
7. Select USB device, and then press the OK button.
8. Insert a Blu-ray Disc that supports BD-LIVE.
9. Select an item from the list of BD-LIVE service contents provided by the disc manufacturer.

-  The way you use BD-LIVE and the provided contents may differ, depending on the disc manufacturer.

## Additional Information

### Notes

#### Connections

##### HDMI OUT

- Certain HDMI output resolutions may not work, depending on your TV.
- You must have an HDMI connection to enjoy videos with 3D technology.
- A long HDMI cable may cause screen noise. If this occurs, set **HDMI Deep Colour** to **Off** in the menu.

#### Settings

##### 3D Settings

- For some 3D discs, to stop a movie during 3D playback, press the **EXIT** button once. The movie stops and the 3D mode option is deactivated.  
To change a 3D option selection when you are playing a 3D movie, press the **EXIT** button once. The Blu-ray menu appears. Press the **EXIT** button again, then select **3D Settings** in the Blu-ray menu.
- Depending on the content and the position of the picture on your TV screen, you may see vertical black bars on the left side, right side, or both sides.

##### TV Aspect Ratio

- Depending on the disc type, some aspect ratios may not be available.
- If you select an aspect ratio and option which is different than the aspect ratio of your TV screen, the picture might appear to be distorted.
- If you select **16:9 Original**, your TV may display **4:3 Pillarbox** (black bars on the sides of the picture).

##### BD Wise (Samsung Products only)

- When **BD Wise** is **On**, the **Resolution** setting automatically defaults to **BD Wise** and **BD Wise** appears in the **Resolution** menu.
- If the product is connected to a device that does not support **BD Wise**, you cannot use the **BD Wise** function.
- For proper operation of **BD Wise**, set the **BD Wise** option in both the product and the TV to **On**.

#### Digital Output

- Be sure to select the correct **Digital Output** or you will hear no sound or just loud noise.
- If the HDMI device (AV receiver, TV) is not compatible with compressed formats (Dolby Digital, DTS), the audio signal outputs as PCM.
- Regular DVDs do not have **BONUSVIEW** audio and **Navigation Sound Effects**.
- Some Blu-ray Discs do not have **BONUSVIEW** audio and **Navigation Sound Effects**.
- This **Digital Output** setup does not affect the analogue (L/R) audio or HDMI audio output to your TV.  
It affects the optical and HDMI audio output when your product is connected to an AV receiver.
- If you play MPEG audio soundtracks, the audio signal outputs as PCM regardless of your **Digital Output** selections (PCM or Bitstream).
- **Digital Output** can be activated when **Sound Output** is set to **TV Speaker**.

#### BD-Live Internet Connection

- The Internet connection may be restricted while you are using BD-LIVE contents.

#### Anynet+ (HDMI-CEC)

- Depending on your TV, certain HDMI output resolutions may not work. Please refer to the user manual of your TV.
- This function is not available if the HDMI cable does not support CEC.
- If your Samsung TV has an Anynet+ logo, then it supports the Anynet+ function.

#### BD Data Management

- In the external memory mode, disc playback may be stopped if you disconnect the USB device in the middle of playback.
- Only those USB devices formatted in the FAT file system (DOS 8.3 volume label) are supported. We recommend you use USB devices that support the USB 2.0 protocol with 4 MB/sec or faster read/write speeds.
- The **Resume Play** function may not work after you format the storage device.
- The total memory available to **BD Data Management** may differ, depending on conditions.

#### DivX® Video On Demand

- For more information about DivX(R) VOD, visit "<http://vod.divx.com>".

# Appendix

## Front Display

- You cannot change the brightness of the  button and the VOL +, - button.

## Speaker Settings

- When **Sound Output** is set to **TV Speaker**, audio is produced by the TV speakers.

## HDMI audio

- When HDMI audio is output to the TV speakers, it is automatically down-mixed to 2 channels.

## Audio Return Channel

- When **Anynet+ (HDMI-CEC)** is **Off**, the **Audio Return Channel** function is not available.
- Using an HDMI cable not certified for ARC (Audio Return Channel) may cause a compatibility problem.
- The ARC function is only available if an ARC-compliant TV is connected.

## Playback

### Playing Video files

- Video files with high bitrates of 20Mbps or more strain the product's capabilities and may stop playing during playback.

### Selecting the Audio Language

- The ◀▶ indicator will not appear on the screen if the **BONUSVIEW** section does not contain any **BONUSVIEW** audio settings.
- The languages available through the **Audio Language** function depend on the languages that are encoded on the disc. This function or certain languages may not be available.
- Some Blu-ray Discs may allow you to select either the PCM or Dolby Digital audio English soundtrack.

### Selecting the Subtitle Language

- Depending on the Blu-ray Disc/DVD, you may be able to change the subtitle language in the **Disc Menu**. Press the **DISC MENU** button.
- This function depends on the selection of subtitles that are encoded on the disc and may not be available on all Blu-ray Discs/DVDs.
- Information about the main feature **BONUSVIEW** mode will also appear if the Blu-ray Disc has a **BONUSVIEW** section.
- This function changes both the primary and secondary subtitles at the same time.
- The total number of primary and secondary subtitles, respectively, is displayed.

## Playing JPEG files

- You can't enlarge the subtitle and PG graphics in the full screen mode.

## Playing Content

### Using the TOOLS button while playing back pictures

- If the home cinema is connected to a BD Wise compliant TV that has **BD Wise On**, the **Picture Settings** menu will not appear.
- The **Background Music** function will not work unless the music file and the photo file are located on the same storage media. Also, sound quality can be impacted by the bitrate of the MP3 music file, the size of the photos, and the encoding method.

## Disk and Format Compatibility

### Disc types and content your Product can Play

| Media | Disc Type   | Details   |
|-------|---|---|
| VIDEO | Blu-ray Disc<br>3D Blu-ray Disc                     | BD-ROM or BD-RE/-R disc recorded in the BD-RE format.   |
|       | DVD-VIDEO,<br>DVD-RW,<br>DVD-R,<br>DVD+RW,<br>DVD+R | DVD-VIDEO, recorded DVD+RW/DVD-RW(V)/DVD-R/+R discs that have been recorded and finalised, or a USB storage media containing DivX, MKV, MP4 contents. |
| MUSIC | CD-RW/-R,<br>DVD-RW/-R,<br>BD-RE/-R                 | Music recorded on CD-RW/-R, DVD-RW/-R, BD-RE/-R discs or a USB storage media containing MP3 or WMA contents.  |
| PHOTO | CD-RW/-R,<br>DVD-RW/-R,<br>BD-RE/-R                 | Photos recorded on CD-RW/-R, DVD-RW/-R, BD-RE/-R discs or a USB storage media containing JPEG contents.   |









- ✎ The product may not play certain CD-RW/-R and DVD-R because of the disc type or recording conditions.
- ✎ If a DVD-RW/-R disc has not been recorded properly in DVD video format, it will not be playable.
- ✎ Your product will not play content that has been recorded on a DVD-R at a bitrate that exceeds 10 Mbps.
- ✎ Your product will not play content that has been recorded on a BD-R or USB device at a bitrate that exceeds 30 Mbps.
- ✎ Playback may not work for some types of discs, or when you use specific operations, such as angle change and aspect ratio adjustment. Information about the discs is written in detail on the disc box. Please refer to this if necessary.
- ✎ When you play a BD-J title, loading may take longer than a normal title or some functions may perform slowly.

### Disc Types your Product cannot Play

- HD DVD
- DVD-ROM/PD/MV-Disc, etc
- DVD-RW(VR mode)
- CVD/CD-ROM/CDV/ CD-G/CD-I/LD (CD-Gs play audio only, not graphics.)
- DVD-RAM
- Super Audio CD (except CD layer)
- 3.9 GB DVD-R Disc for Authoring.



- ✎ This product may not respond to all operating commands because some Blu-ray Disc, DVD, and CD discs allow specific or limited operation and provide only certain features during playback. Please note that this is not a defect in the product.
- ✎ Samsung cannot guarantee that this product will play every disc bearing the Blu-ray Disc, DVD, or CD logo because disc formats evolve, and problems and errors may occur during the creation of Blu-ray Disc, DVD, and CD software and/or the manufacture of discs.
- ✎ Please contact the SAMSUNG Customer Care Centre at, if you have questions or encounter difficulty when playing Blu-ray Disc, DVD, or CD discs in this product. Also, refer to rest of this user manual for additional information on playback restrictions.
- ✎ Some commercial discs and DVD discs purchased outside your region may not play on this product.

### Logos of Discs the Product can Play

|   |   |
|---|---|
|  |  |
| Blu-ray Disc  | 3D Blu-ray Disc   |
|  |  |
| BD-LIVE   | Dolby   |
|  |  |
| DTS   |   |
|  |  |
| Java  | DivX  |
|  |   |
| PAL broadcast system in U.K, France, Germany, etc.                                |   |

### Region Code

Both products and discs are coded by region. These regional codes must match for a disc to play. If the codes do not match, the disc will not play. The Region Number for this product is displayed on the rear panel of the product.

| Disc Type    | Region Code   | Area  |
|--------------|---|---|
| Blu-ray Disc |  | North America, Central America, South America, Korea, Japan, Taiwan, Hong Kong and South East Asia. |
|              |  | Europe, Greenland, French territories, Middle East, Africa, Australia and New Zealand.              |
|              |  | India, China, Russia, Central and South Asia.   |

# Appendix

|           |   |  |
|-----------|---|--|
| DVD-VIDEO |  | The U.S., U.S. territories and Canada  |
|           |  | Europe, Japan, the Middle East, Egypt, Africa, Greenland                                   |
|           |  | Taiwan, Korea, the Philippines, Indonesia, Hong Kong                                       |
|           |  | Mexico, South America, Central America, Australia, New Zealand, Pacific Islands, Caribbean |
|           |  | Russia, Eastern Europe, India, North Korea, Mongolia                                       |
|           |  | China  |

 If the Region number of a Blu-ray Disc/DVD does not correspond to the Region number of this product, the product cannot play the disc.

## AVCHD (Advanced Video Codec High Definition)

- This product can play back AVCHD format discs. These discs are normally recorded and used in camcorders.
- The AVCHD format is a high definition digital video camera format.
- The MPEG-4 AVC/H.264 format compresses images with greater efficiency than the conventional image compressing format.
- Some AVCHD discs use the “x.v.Colour” format. This product can play back AVCHD discs that use the “x.v.Colour” format.
- “x.v.Colour” is a trademark of Sony Corporation.
- “AVCHD” and the AVCHD logo are trademarks of Matsushita Electronic Industrial Co., Ltd. and Sony Corporation.

 Some AVCHD format discs may not play, depending on the recording conditions.

 AVCHD format discs need to be finalised.

 “x.v.Colour” offers a wider colour range than normal DVD camcorder discs.

 Some DivX, MKV and MP4 format discs may not play, depending on their video resolution and frame rate.

## Supported Formats

### Notes on the USB connection

- Your product supports USB storage media, MP3 players, digital cameras, and USB card readers.
- The product does not support folder or file names longer than 128 characters.
- Some USB/digital camera devices may not be compatible with the product.
- Your product supports the FAT 16, FAT 32, and NTFS file systems.
- Connect USB devices directly to the product’s USB port. Connecting through a USB cable may cause compatibility problems.
- Inserting more than one memory device into a multi-card reader may cause the reader to operate improperly.
- The product does not support the PTP (Peer to Peer) protocol.
- Do not disconnect a USB device while it is transferring or recording data.
- The bigger the image resolution, the longer the image takes to display.
- This product cannot play MP3 files with DRM (Digital Rights Management) downloaded from commercial sites.
- Your product only supports video that is under 30fps (frame rate).
- Your product only supports USB Mass Storage Class (MSC) devices such as thumb drives and USB HDD. (HUB is not supported.)
- Certain USB HDD Devices, multi-card readers and thumb drives may not be compatible with this product.
- If some USB devices require excessive power, they may be limited by the circuit safety device.
- If playback from a USB HDD is unstable, provide additional power by plugging the HDD into a wall socket. If the problem continues, contact the USB HDD manufacturer.
- SAMSUNG is not responsible for any data file damage or data loss.



# Appendix

## Music File Support

| File Extension          | Type  | Codec               | Comments  |
|-------------------------|-------|---------------------|---|
| *.mp3                   | MPEG  | MPEG1 Audio Layer 3 | -   |
| *.m4a<br>*.mpa<br>*.aac | MPEG4 | AAC                 | -   |
| *.flac                  | FLAC  | FLAC                | Supports up to 2ch  |
| *.ogg                   | OGG   | Vorbis              | Supports up to 2ch  |
| *.wma                   | WMA   | WMA                 | Supports WMA 10 Pro (Up to 5.1)<br>Does not support WMA lossless audio<br>Supports up to M2 profile |
| *.wav                   | wav   | wav                 | -   |
| *.mid<br>*.midi         | midi  | midi                | type 0 and type 1<br>Seek not supported<br>Supported on USB only                                    |
| *.ape                   | ape   | ape                 | NonSmart not supported  |
| *.aif<br>*.aiff         | AIFF  | AIFF                | -   |
| *.m4a                   | ALAC  | ALAC                | -   |

## Picture File Support

| File Extension  | Type | Resolution | Comments |
|-----------------|------|------------|----------|
| *.jpg<br>*.jpeg | JPEG | 15360x8640 | -        |
| *.png           | PNG  | 4096x4096  | -        |
| *.bmp           | BMP  | 4096x4096  | -        |
| *.mpo           | MPO  | 15360x8640 | -        |

## Digital Output Selections

| Setup                        | PCM                          | Bitstream (Unprocessed)  | Bitstream (Re-encoded DTS)   | Bitstream (Re-encoded Dolby D)   |   |
|------------------------------|------------------------------|--|--|--|---|
| <b>Connection</b>            |                              | <b>HDMI supported AV receiver</b>  |  |  |   |
| Audio Stream on Blu-ray Disc | PCM                          | Up to PCM 7.1ch  | PCM  | DTS re-encoded<br>Re-encoded Dolby Digital *   |   |
|                              | Dolby Digital                | Up to PCM 5.1ch  | Dolby Digital  |  |   |
|                              | Dolby Digital Plus           | HT-H7500WM :<br>Up to PCM 5.1ch<br>HT-H7750WM :<br>Up to PCM 7.1ch   | Dolby Digital Plus   |  |   |
|                              | Dolby TrueHD                 |  | Dolby TrueHD   |  |   |
|                              | DTS                          |  | DTS  |  |   |
|                              | DTS-HD High Resolution Audio |  | DTS-HD High Resolution Audio   |  |   |
|                              | DTS-HD Master Audio          |  | DTS-HD Master Audio  |  |   |
| Audio Stream on DVD          | PCM                          | PCM 2ch  |  |  |   |
|                              | Dolby Digital                | Up to PCM 5.1ch  | Dolby Digital  |  |   |
|                              | DTS                          | HT-H7500WM :<br>Up to PCM 5.1ch<br>HT-H7750WM :<br>Up to PCM 7.1ch   | DTS  |  |   |
| Definition for Blu-ray Disc  | Any                          | Decodes the main feature audio and BONUSVIEW audio stream together into PCM audio and adds Navigation Sound Effects. | Outputs only the main feature audio stream so that your AV receiver can decode the audio bitstream. You will not hear BONUSVIEW audio or Navigation Sound Effects. | Decodes the main feature audio and BONUSVIEW audio stream together into PCM audio and adds Navigation Sound Effects, then re-encodes the PCM audio into DTS bitstream. | Decodes the main feature audio and BONUSVIEW audio stream together into PCM audio and adds Navigation Sound Effects, then re-encodes the PCM audio into Dolby Digital bitstream or PCM. |

- If the Source Stream is 2ch or mono, "Re-encoded Dolby D" Setting are not applied. Output will be PCM 2ch.

Blu-ray Discs may include three audio streams :

- Main Feature Audio : The audio soundtrack of the main feature.
- BONUSVIEW audio : An additional soundtrack such as the director or actor's commentary.
- Navigation Sound Effects : When you choose some menu navigation options, Navigation Sound Effects may sound. Navigation Sound Effects are different on each Blu-ray Disc.

# Appendix

## Resolution according to the content type

### HT-H7500WM

| Blu-ray Disc/E-contents/Digital Contents playback |                           |                             | DVD playback                    |
|---|---------------------------|-----------------------------|---------------------------------|
| Setup   | Output                    | HDMI Mode                   |                                 |
|   |                           | Blu-ray Disc                | E-contents/<br>Digital contents |
| BD Wise   |                           | Resolution of Blu-ray Disc  | 1080p@60F                       |
| Auto  |                           | Max. Resolution of TV input |                                 |
|   | 1080p@60F                 | 1080p@60F                   |                                 |
|   | 1080p                     | -                           |                                 |
|   | Movie Frame : Auto (24Fs) | 1080p@24F                   |                                 |
|   | 1080i                     | 1080i                       |                                 |
|   | 720p                      | 720p                        |                                 |
|   | 576p/480p                 | 576p/480p                   |                                 |

### HT-H7750WM

| Setup   |                       | Content Type                              | Blu-ray Disc                | E-contents/<br>Digital contents |
|---------|-----------------------|---|-----------------------------|---------------------------------|
| BD Wise |                       |   | Resolution of Blu-ray Disc  | 1080p@60F                       |
| Auto    | Movie Frame :<br>Auto | UHD Output : Auto                         | 2160p@24F                   | 2160p@24F                       |
|         |                       | UHD Output : Off                          | 1080p@24F                   | 1080p@24F                       |
|         |                       | Movie Frame : Off                         | Max. Resolution of TV input | Max. Resolution of TV input     |
|         |                       | Movie Frame : Auto (24Fs)<br>★ 1080p only | 1080p@24F                   | 1080p@24F                       |
|         |                       | 1080p                                     | 1080p@60F                   | 1080p@60F                       |
|         |                       | 1080i                                     | 1080i                       | 1080i                           |
|         |                       | 720p                                      | 720p                        | 720p                            |
|         |                       | 576p/480p                                 | 576p/480p                   | 576p/480p                       |

| Setup   |                       |                                | Content Type   | DVD                         |
|---------|-----------------------|--------------------------------|--|-----------------------------|
| BD Wise |                       |                                |  | 576i/480i                   |
| Auto    | Movie Frame :<br>Auto | DVD 24fps<br>Conversion : Auto | UHD Output : Auto  | 2160p@24F                   |
|         |                       |                                | UHD Output : Off   | 1080p@24F                   |
|         |                       |                                | DVD 24fps Conversion : Off                                       | Max. Resolution of TV input |
|         |                       |                                | Movie Frame : Off  | Max. Resolution of TV input |
|         |                       |                                | Movie Frame : Auto (DVD 24fps Conversion : Auto)<br>★ 1080p only | 1080p@24F                   |
|         |                       |                                | 1080p  | 1080p@60F                   |
|         |                       |                                | 1080i  | 1080i                       |
|         |                       |                                | 720p   | 720p                        |
|         |                       |                                | 576p/480p  | 576p/480p                   |

- 🔧 If the TV you connected to the product does not support Movie Frame or the resolution you selected, the message "If no pictures are shown after selecting 'Yes', please wait for 15 seconds to return to the previous resolution. Do you want to change the resolution?" appears. If you select Yes, the TV's screen will go to blank for 15 seconds, and then the resolution will revert to the previous resolution automatically.
- 🔧 If the screen stays blank after you have changed the resolution, remove all discs, and then press and hold the **■** button on the top of the product for more than 5 seconds. All settings are restored to the factory default. Run the Initial Settings procedure again. Then, go to **Settings > Picture > Resolution** in the Menu, and select the correct resolution for your TV.
- 🔧 When you run the Initial Settings procedure, re-select the language and aspect ratio (screen size and format) only. Resetting does not affect your network settings, so you should be able to skip Network Setup and Software Update.
- 🔧 When the factory default settings are restored, all stored user BD data will be deleted.
- 🔧 The Blu-ray Disc must have the 24 frame feature for the product to use the Movie Frame (24fps) mode.

## Troubleshooting

Refer to the table below when this product does not function properly. If the problem you are experiencing is not listed below or if the instructions below do not help, turn off the product, disconnect the power cord and contact the nearest authorized dealer or Samsung Electronics Service Centre.

| Symptom   | Check/Remedy  |
|---|---|
| You cannot eject the disc.  | <ul style="list-style-type: none"> <li>• Is the power cord plugged securely into the outlet?</li> <li>• Turn off the power, and then turn it back on.</li> </ul>  |
| Playback does not start.  | <ul style="list-style-type: none"> <li>• Check the region number of the Blu-ray/DVD disc. Blu-ray/DVD disc purchased from abroad may not be playable.</li> <li>• CD-ROMs and DVD-ROMs cannot be played on this product.</li> <li>• Make sure that the rating level is correct.</li> </ul>                       |
| Playback does not start immediately when you press the <b>▶  </b> button. | <ul style="list-style-type: none"> <li>• Are you using a deformed disc or a disc with scratches on the surface?</li> <li>• Wipe the disc clean.</li> </ul>  |
| No sound.   | <ul style="list-style-type: none"> <li>• The home cinema does not play sound during fast playback, slow playback, and step motion playback.</li> <li>• Are the speakers connected properly? Is the speaker setup correctly customized?</li> <li>• Is the disc severely damaged?</li> </ul>                      |
| HT-H7500WM : You can only hear sound from a few speakers, but not all 6.  | <ul style="list-style-type: none"> <li>• On certain Blu-ray/DVD discs, sound is output from the front speakers only.</li> <li>• Check if the speakers are connected properly.</li> <li>• Adjust the volume.</li> </ul>  |
| HT-H7750WM : You can only hear sound from a few speakers, but not all 8.  | <ul style="list-style-type: none"> <li>• When playing audio from a CD, the radio, or a TV, the unit outputs sound to the front speakers only.</li> </ul>  |
| HT-H7500WM : Dolby Digital 5.1 CH Surround Sound is not produced.         | <ul style="list-style-type: none"> <li>• Is there "Dolby Digital 5.1 CH" mark on the disc? Dolby Digital 5.1 CH Surround Sound is produced only if the disc is recorded with 5.1 channel sound.</li> <li>• Is the audio language correctly set to Dolby Digital 5.1-CH in the information display?</li> </ul>   |
| HT-H7750WM : Dolby Digital 7.1 CH Surround Sound is not produced.         | <ul style="list-style-type: none"> <li>• Is there "Dolby Digital 7.1 CH" marked on the disc? Dolby Digital 7.1 CH Surround Sound is produced only if the disc is recorded with 7.1 channel sound.</li> <li>• Is the audio language correctly set to Dolby Digital 7.1-CH in the information display?</li> </ul> |

# Appendix

| Symptom  | Check/Remedy  |
|--|---|
| The remote control does not work.  | <ul style="list-style-type: none"> <li>• Are you operating the remote within its operational range and within the proper angle relative to the sensor?</li> <li>• Are the batteries drained?</li> </ul>   |
| <ul style="list-style-type: none"> <li>• The disc is rotating but there is no picture.</li> <li>• Picture quality is poor and the picture is shaking.</li> </ul>                           | <ul style="list-style-type: none"> <li>• Is the TV power on?</li> <li>• Are the video cables connected properly?</li> <li>• Is the disc dirty or damaged?</li> <li>• A poorly manufactured disc may not be playable.</li> </ul>   |
| Audio language and subtitles do not work.  | <ul style="list-style-type: none"> <li>• The Audio Language and subtitle functions will not work if the disc does not contain them.</li> </ul>  |
| The menu screen does not appear even when you select the menu function.  | <ul style="list-style-type: none"> <li>• Are you using a disc that does not contain menus?</li> </ul>   |
| The aspect ratio cannot be changed.  | <ul style="list-style-type: none"> <li>• You can play 16:9 Blu-ray/DVD discs in 16:9 Full mode, 4:3 Letter Box mode, or 4:3 Pan-Scan mode, but 4:3 Blu-ray/DVD discs are played in 4:3 mode only. Refer to the Blu-ray Disc jacket, and then select the appropriate function.</li> </ul>  |
| <ul style="list-style-type: none"> <li>• The product is not working. (Example: The power goes off or you hear a strange noise.)</li> <li>• The Product is not working normally.</li> </ul> | <ul style="list-style-type: none"> <li>• Press and hold the remote control's <b>EXIT</b> button for 5 seconds in STANDBY mode. This will reset the unit. <ul style="list-style-type: none"> <li>- Using the RESET function will erase all stored settings. Do not use this function unless necessary.</li> </ul> </li> </ul>  |
| You have forgotten the rating level password.  | <ul style="list-style-type: none"> <li>• With no disc in the product, press and hold the product's <b>INIT</b> button for longer than 5 seconds. <b>INIT</b> appears on the display and all settings will return to their default values. <ul style="list-style-type: none"> <li>- Using the RESET function will erase all stored settings. Do not use this function unless necessary.</li> </ul> </li> </ul>   |
| Can't receive radio broadcasts.  | <ul style="list-style-type: none"> <li>• Is the antenna connected properly?</li> <li>• If the antenna's input signal is weak, install an external FM antenna in an area with good reception.</li> </ul>   |
| While listening to TV audio through the product, there is no sound.  | <ul style="list-style-type: none"> <li>• If you press the <b>OPEN/CLOSE</b> button while listening to TV audio using the D. IN or AUX functions, the Blu-ray/DVD disc functions are turned on and the TV audio is muted.</li> </ul>   |
| "Not Available" appears on screen.   | <ul style="list-style-type: none"> <li>• The features or action cannot be completed at this time because: <ol style="list-style-type: none"> <li>1. The Blu-ray/DVD disc's software restricts it.</li> <li>2. The Blu-ray/DVD disc's software doesn't support the feature (e.g., angles)</li> <li>3. The feature is not available at the moment.</li> <li>4. You've requested a title or chapter number or search time that is out of range.</li> </ol> </li> </ul> |
| If the HDMI output is set to a resolution your TV cannot support (for example, 1080p), you may not see a picture on your TV.   | <ul style="list-style-type: none"> <li>• Press and hold the <b>RESET</b> button on front panel for more than 5 seconds with no disc in the product. All settings will revert to their factory settings.</li> </ul>  |

| Symptom  | Check/Remedy   |
|--|--|
| No HDMI output.  | <ul style="list-style-type: none"> <li>• Check the connection between the TV and the HDMI jack of the product.</li> <li>• Check if your TV supports 576p/480p/720p/1080i/1080p HDMI input resolution.</li> </ul>   |
| Abnormal HDMI output appears on the screen.                            | <ul style="list-style-type: none"> <li>• If random noise appears on the screen, it means that TV does not support HDCP (High-bandwidth Digital Content Protection).</li> </ul>   |
| <b>AllShare function</b>   |  |
| You can see folders shared through AllShare, but cannot see the files. | <ul style="list-style-type: none"> <li>• AllShare only shows Video, Photo, and Music files. Other types of files are not displayed.</li> </ul>   |
| Video plays intermittently.  | <ul style="list-style-type: none"> <li>• Check if the network is stable.</li> <li>• Check if the network cable is properly connected and if the network is overloaded.</li> <li>• The wireless connection between the DLNA compatible device and the product is unstable. Check the connection.</li> </ul>   |
| The AllShare connection between the product and PC is unstable.        | <ul style="list-style-type: none"> <li>• IP addresses under the same subnetnetwork should be unique, otherwise IP collision can results in such a phenomenon.</li> <li>• Check if you have a firewall enabled. If so, disable the firewall function.</li> </ul>  |
| <b>BD-LIVE</b>   |  |
| The home cinema cannot connect to the BD-LIVE server.                  | <ul style="list-style-type: none"> <li>• Test whether the network connection is active by using the Network Status function.</li> <li>• Check whether a USB memory device is connected to the product.</li> <li>• The memory device must have at least 1GB of free space to accommodate the BD-LIVE service. You can check the available size in <b>BD Data Management</b>. (See page 51)</li> <li>• See if the <b>BD-Live Internet Connection</b> option is set to <b>Allow(All)</b>.</li> <li>• If all above fails, contact the contents provider or update to the latest firmware.</li> </ul> |
| When using the BD-LIVE service, an error occurs.                       | <ul style="list-style-type: none"> <li>• The USB memory device must have at least 1GB of free space to accommodate the BD-LIVE service. You can check the available size in <b>BD Data Management</b>. (See page 51)</li> </ul>  |

 When the factory default settings are restored, all stored user BD data is deleted.



Hereby, Samsung Electronics, declares that this equipment is in compliance with the essential requirements and other relevant provisions of Directive 1999/5/EC.

The original Declaration of Conformity may be found at <http://www.samsung.com>, go to Support > Search Product Support and enter the model name.

This equipment may be operated in all EU countries.  
This equipment may only be used indoors.

# Appendix

## Specifications

|           |   |            |   |
|-----------|---|------------|---|
| General   | Weight  |            | 2.7 kg  |
|           | Dimensions                                    |            | 430.0 (W) x 55.0 (H) x 312.0 (D) mm                                     |
|           | Operating Temperature Range                   |            | +5°C to +35°C   |
|           | Operating Humidity Range                      |            | 10 % to 75 %  |
| FM Tuner  | Signal/noise ratio                            |            | 55 dB   |
|           | Usable sensitivity                            |            | 12 dB   |
|           | Total harmonic distortion                     |            | 0.5 %   |
| HDMI      | Video   | HT-H7500WM | 1080p, 1080i, 720p, 576p/480p   |
|           |   | HT-H7750WM | 2D : 2160p, 1080p, 1080i, 720p, 576p/480p<br>3D : 1080p, 720p           |
|           | Audio   |            | PCM multichannel audio, Bitstream audio, PCM audio                      |
| Amplifier | Front speaker output                          |            | 165W x 2(3Ω)  |
|           | Front Top speaker output<br>(HT-H7750WM only) |            | 165W x 2(3Ω)  |
|           | Centre speaker output                         |            | 170W(3Ω)  |
|           | Surround speaker output                       |            | 165W x 2(3Ω)  |
|           | Subwoofer speaker output                      |            | 170W(3Ω)  |
|           | Frequency response                            |            | Analogue input : 20Hz~20kHz (±3dB)<br>Digital input : 20Hz~40kHz (±4dB) |
|           | S/N Ratio                                     |            | 70dB  |
|           | Channel separation                            |            | 60dB  |
|           | Input sensitivity                             |            | (AUX)500mV  |

| HT-H7500WM     |           |                 |                             |             |               |                                    |                     |
|----------------|-----------|-----------------|-----------------------------|-------------|---------------|------------------------------------|---------------------|
| Speaker system | Impedance | Frequency range | Output sound pressure level | Rated input | Maximum input | Dimensions (W x H x D) (Unit : mm) | Weights (Unit : kg) |
| Front          | 3 Ω       | 140Hz~20kHz     | 87dB/W/M                    | 165W        | 330W          | 95.0 x 280.0 x 101.0               | 1.75                |
| Surround       |           |                 |                             |             |               | 95.0 x 150.0 x 101.0               | 0.64                |
| Centre         |           | 40Hz ~ 160Hz    | 88dB/W/M                    | 170W        | 340W          | 320.0 x 80.5 x 101.0               | 1.02                |
| Subwoofer      |           |                 |                             |             |               | 200.0 x 390.0 x 350.0              | 5.75                |

| HT-H7750WM          |           |                 |                             |             |               |   |                     |
|---------------------|-----------|-----------------|-----------------------------|-------------|---------------|---|---------------------|
| Speaker system      | Impedance | Frequency range | Output sound pressure level | Rated input | Maximum input | Dimensions (W x H x D) (Unit : mm)                          | Weights (Unit : kg) |
| Front/<br>Front Top | 3 Ω       | 140Hz~20kHz     | 87dB/W/M                    | 165W        | 330W          | 95.0 x 1215.0 x 101.0<br>(Stand base: 276.0 x 23.0 x 264.0) | 5.01                |
| Surround            |           |                 |                             |             |               | 95.0 x 1160.0 x 101.0<br>(Stand base: 276.0 x 23.0 x 264.0) | 4.73                |
| Centre              |           | 40Hz ~ 160Hz    | 88dB/W/M                    | 170W        | 340W          | 320.0 x 80.5 x 101.0  | 1.02                |
| Subwoofer           |           |                 |                             |             |               | 200.0 x 390.0 x 350.0                                       | 5.75                |

- Network speeds equal to or below 10Mbps are not supported.
- Samsung Electronics Co., Ltd reserves the right to change the specifications without notice.
- Weight and dimensions are approximate.
- Design and specifications are subject to change without prior notice.
- For the power supply and Power Consumption, refer to the label attached to the product.

#### □ SWA-6000

|                             |                         |
|-----------------------------|-------------------------|
| Weight                      | 1.1 kg                  |
| Dimensions (W x H x D)      | 76.2 x 228.6 x 152.4 mm |
| Operating Temperature Range | +5°C to +35°C           |
| Operating Humidity Range    | 10 % to 75 %            |
| Output                      | 165W x 2 CH             |
| Frequency range             | 20Hz~20KHz              |
| S/N Ratio                   | 65dB                    |

# Appendix

## Licences



Manufactured under license from Dolby Laboratories. Dolby and the double-D symbol are trademarks of Dolby Laboratories.



For DTS patents, see <http://patents.dts.com>. Manufactured under license from DTS Licensing Limited. DTS, DTS-HD, the Symbol, DTS and the Symbol together, & DTS-HD and the Symbol together are registered trademarks of DTS,

Inc. DTS-HD Master Audio | Essential and DTS Neo:Fusion II are trademarks of DTS, Inc. © DTS, Inc. All Rights Reserved.



ABOUT DIVX VIDEO: DivX® is a digital video format created by DivX, LLC, a subsidiary of Rovi Corporation. This is an official DivX Certified® device that has passed rigorous testing to verify that it plays DivX video. Visit [divx.com](http://divx.com) for more information and software tools to convert your files into DivX videos.

ABOUT DIVX VIDEO-ON-DEMAND: This DivX Certified® device must be registered in order to play purchased DivX Video-on-Demand (VOD) movies. To obtain your registration code, locate the DivX VOD section in your device setup menu. Go to [vod.divx.com](http://vod.divx.com) for more information on how to complete your registration.

DivX Certified® to play DivX® video up to HD 1080p, including premium content.

DivX®, DivX Certified® and associated logos are trademarks of Rovi Corporation or its subsidiaries and are used under licence.

Covered by one or more of the following U.S. patents : 7,295,673; 7,460,668; 7,515,710; 7,519,274



The terms HDMI and HDMI High-Definition Multimedia Interface, and the HDMI Logo are trademarks or registered trademarks of HDMI Licensing LLC in the United States and other countries.



Oracle and Java are registered trademarks of Oracle and/or its affiliates. Other names may be trademarks of their respective owners.

This item incorporates copy protection technology that is protected by U.S. patents and other intellectual property rights of Rovi Corporation. Reverse engineering and disassembly are prohibited.

Blu-ray Disc™, Blu-ray™, and the logos are trademarks of Blu-ray Disc Association.

This product uses Cinavia technology to limit the use of unauthorized copies of some commercially-produced film and videos and their soundtracks. When a prohibited use of an unauthorized copy is detected, a message will be displayed and playback or copying will be interrupted.

More information about Cinavia technology is provided at the Cinavia Online Consumer Information Centre at <http://www.cinavia.com>. To request additional information about Cinavia by mail, send a postcard with your mailing address to: Cinavia Consumer Information Centre, P.O. Box 86851, San Diego, CA, 92138, USA."

This product incorporates proprietary technology under license from Verance Corporation and is protected by U.S. Patent 7,369,677 and other U.S. and worldwide patents issued and pending as well as copyright and trade secret protection for certain aspects of such technology. Cinavia is a trademark of Verance Corporation. Copyright 2004-2010 Verance Corporation. All rights reserved by Verance. Reverse engineering or disassembly is prohibited.

- Open Source Licence Notice

In the case of using open source software, Open Source Licences are available on the product menu.



## Contact SAMSUNG WORLD WIDE

If you have any questions or comments relating to Samsung products, please contact the SAMSUNG customer care centre.

| Area      | Contact Centre ☎  | Web Site  |
|-----------|---|---|
| ■ Europe  |   |   |
| AUSTRIA   | 0800 - SAMSUNG (0800 - 7267864)   | <a href="http://www.samsung.com/at/support">www.samsung.com/at/support</a>  |
| BELGIUM   | 02-201-24-18  | <a href="http://www.samsung.com/be/support">www.samsung.com/be/support</a><br><a href="http://www.samsung.com/be_fr/support">www.samsung.com/be_fr/support</a> (French) |
| BOSNIA    | 051 331 999   | <a href="http://www.samsung.com/support">www.samsung.com/support</a>  |
| BULGARIA  | 07001 33 11 , sharing cost  | <a href="http://www.samsung.com/bg/support">www.samsung.com/bg/support</a>  |
| CROATIA   | 062 726 786   | <a href="http://www.samsung.com/hr/support">www.samsung.com/hr/support</a>  |
| CZECH     | 800 - SAMSUNG (800-726786)  | <a href="http://www.samsung.com/cz/support">www.samsung.com/cz/support</a>  |
| DENMARK   | 70 70 19 70   | <a href="http://www.samsung.com/dk/support">www.samsung.com/dk/support</a>  |
| FINLAND   | 030-6227 515  | <a href="http://www.samsung.com/fi/support">www.samsung.com/fi/support</a>  |
| FRANCE    | 01 48 63 00 00  | <a href="http://www.samsung.com/fr/support">www.samsung.com/fr/support</a>  |
| GERMANY   | 0180 6 SAMSUNG bzw.<br>0180 6 7267864*<br>0180 6 67267864*<br>(*0,20 €/Anruf aus dem dt. Festnetz, aus dem Mobilfunk max. 0,60 €/Anruf) | <a href="http://www.samsung.com/de/support">www.samsung.com/de/support</a>  |
| CYPRUS    | 8009 4000 only from landline , toll free  |   |
| GREECE    | 80111-SAMSUNG (80111 726 7864) only from land line<br>(+30) 210 6897691 from mobile and land line                                       | <a href="http://www.samsung.com/gr/support">www.samsung.com/gr/support</a>  |
| HUNGARY   | 0680SAMSUNG (0680-726-786)<br>0680PREMIUM (0680-773-648)  | <a href="http://www.samsung.com/hu/support">http://www.samsung.com/hu/support</a>   |
| ITALIA    | 800-SAMSUNG (800.7267864)   | <a href="http://www.samsung.com/it/support">www.samsung.com/it/support</a>  |
| LUXEMBURG | 261 03 710  | <a href="http://www.samsung.com/support">www.samsung.com/support</a>  |

| Area        | Contact Centre ☎  | Web Site   |
|-------------|---|--|
| MONTE-NEGRO | 020 405 888   | <a href="http://www.samsung.com/support">www.samsung.com/support</a>   |
| SLOVENIA    | 080 697 267<br>090 726 786  | <a href="http://www.samsung.com/si/support">www.samsung.com/si/support</a>   |
| NETHERLANDS | 0900-SAMSUNG (0900-7267864) (€ 0,10/Min)  | <a href="http://www.samsung.com/nl/support">www.samsung.com/nl/support</a>   |
| NORWAY      | 815 56480   | <a href="http://www.samsung.com/no/support">www.samsung.com/no/support</a>   |
| POLAND      | 0 801-172-678* lub +48 22 607-93-33 **<br>*(całkowity koszt połączenia jak za 1 impuls według taryfy operatora)<br>**(koszt połączenia według taryfy operatora) | <a href="http://www.samsung.com/pl/support">www.samsung.com/pl/support</a>   |
| PORTUGAL    | 808 20 7267   | <a href="http://www.samsung.com/pt/support">www.samsung.com/pt/support</a>   |
| ROMANIA     | 08008 SAMSUNG (08008 726 7864)<br>TOLL FREE No.   | <a href="http://www.samsung.com/ro/support">www.samsung.com/ro/support</a>   |
| SERBIA      | 011 321 6899  | <a href="http://www.samsung.com/rs/support">www.samsung.com/rs/support</a>   |
| SLOVAKIA    | 0800 - SAMSUNG(0800-726 786)  | <a href="http://www.samsung.com/sk/support">www.samsung.com/sk/support</a>   |
| SPAIN       | 0034902172678   | <a href="http://www.samsung.com/es/support">www.samsung.com/es/support</a>   |
| SWEDEN      | 0771 726 7864 (SAMSUNG)   | <a href="http://www.samsung.com/se/support">www.samsung.com/se/support</a>   |
| SWITZERLAND | 0848 726 78 64 (0848-SAMSUNG)   | <a href="http://www.samsung.com/ch_fr/support">www.samsung.com/ch_fr/support</a> (German)<br><a href="http://www.samsung.com/ch_fr/support">www.samsung.com/ch_fr/support</a> (French) |
| U.K         | 0330 SAMSUNG (7267864)  | <a href="http://www.samsung.com/uk/support">www.samsung.com/uk/support</a>   |
| EIRE        | 0818 717100   | <a href="http://www.samsung.com/ie/support">www.samsung.com/ie/support</a>   |
| LITHUANIA   | 8-800-77777   | <a href="http://www.samsung.com/lt/support">www.samsung.com/lt/support</a>   |
| LATVIA      | 8000-7267   | <a href="http://www.samsung.com/lv/support">www.samsung.com/lv/support</a>   |
| ESTONIA     | 800-7267  | <a href="http://www.samsung.com/ee/support">www.samsung.com/ee/support</a>   |



## Correct disposal of batteries in this product

(Applicable in countries with separate collection systems)

This marking on the battery, manual or packaging indicates that the batteries in this product should not be disposed of with other household waste at the end of their working life. Where marked, the chemical symbols Hg, Cd or Pb indicate that the battery contains mercury, cadmium or lead above the reference levels in EC Directive 2006/66. If batteries are not properly disposed of, these substances can cause harm to human health or the environment.

To protect natural resources and to promote material reuse, please separate batteries from other types of waste and recycle them through your local, free battery return system.



## Correct Disposal of This Product (Waste Electrical & Electronic Equipment)

(Applicable in countries with separate collection systems)

This marking on the product, accessories or literature indicates that the product and its electronic accessories (e.g. charger, headset, USB cable) should not be disposed of with other household waste at the end of their working life. To prevent possible harm to the environment or human health from uncontrolled waste disposal, please separate these items from other types of waste and recycle them responsibly to promote the sustainable reuse of material resources.

Household users should contact either the retailer where they purchased this product, or their local government office, for details of where and how they can take these items for environmentally safe recycling.

Business users should contact their supplier and check the terms and conditions of the purchase contract. This product and its electronic accessories should not be mixed with other commercial wastes for disposal.



AH68-02710A-02



AH68-02710A-02